

STIHL 056



STIHL®

Warning:
Always follow safety precautions in
owner's manual – improper use
can cause serious injury.

Important Safety Precautions

1. Do not operate a chain saw when you are fatigued.
2. Use safety footwear, snug-fitting clothing, and eye, hearing and head protection devices.
3. Use caution when handling fuel. Move the chain saw at least 10 feet (3 m) from the fueling point before starting the engine.
4. Do not allow other persons to be near the chain saw when starting or cutting with the chain saw. Keep bystanders and animals out of the work area.
5. Do not start cutting until you have a clear work area, secure footing, and a planned retreat path from the falling tree.
6. Hold the chain saw firmly with both hands, the right hand on the rear handle and the left hand on the front handle, when the engine is running. Use a firm grip with thumbs and fingers encircling the chain saw handles.
7. Keep all parts of your body away from the saw chain when the engine is running.
8. Before you start the engine, make sure the saw chain is not contacting anything.
9. Carry the chain saw with the engine stopped, the guide bar and saw chain to the rear, and the muffler away from your body.
10. Do not operate a chain saw that is damaged, improperly adjusted, or is not completely and securely assembled. Be sure that the saw chain stops moving when the throttle trigger is released.
11. Shut off the engine before setting it down.
12. Use extreme caution when cutting small size brush and saplings because slender material may catch the saw chain and be whipped toward you or pull you off balance.
13. When cutting a limb that is under tension be alert for spring back so that you will not be struck when the tension in the wood fibers is released.

continued on the back inside cover →

STIHL 056 AV electronic, 056 AV electronic Quickstop

Congratulations!

You are the owner of a precision-manufactured STIHL chain saw designed to give you long and dependable service. To receive maximum performance and satisfaction from your STIHL chain saw, it is important that you read and understand the maintenance and safety precautions before using your saw. Contact your STIHL Dealer or the STIHL Distributor for your area if you do not understand any of the instructions or warnings in this Manual.

This Manual contains warnings regarding your saw, operating and safety instructions for all STIHL 056 series power saws.

Warning!

Because a chain saw is a high-speed wood-cutting tool, some special safety precautions must be observed as with any other power saw to reduce the risk of personal accidents. Careless or improper use may cause serious or even fatal injury.

It is important that you fully understand the contents of this Manual and that you allow only persons who understand this Manual to operate your chain saw.

Pay special attention to the cutting techniques and safety precautions outlined on pages 6 to 18.

STIHL's philosophy is to continually improve all of its products. As a result, engineering changes and improvements are made from time-to-time. Written notices relating to such changes are sent to STIHL Dealers and are available to you. If the operating characteristics or the appearance of your saw differs from those described in this Manual, please contact your local STIHL Dealer for updated information and assistance.

Operating Instructions Sharpening and Maintenance of Saw Chains

Contents

Controls	2
Fuel	3
Chain Oil	3
Mounting the Cutting Attachment	4
Chain Brake	5
Safety Precautions	6
Starting	19
Oil Quantity Control	21
Cutting Attachment	22
Replacing the Chain Sprocket	24
Air Filter	25
Carburetor	26
Rewind Starter	27
Oil Inspection Window	29
General Maintenance	29
Specifications	30
Sharpening and Maintenance of Saw Chain	31

STIHL[®]

Andreas Stihl
Postfach 1760

D-7050 Waiblingen

Controls

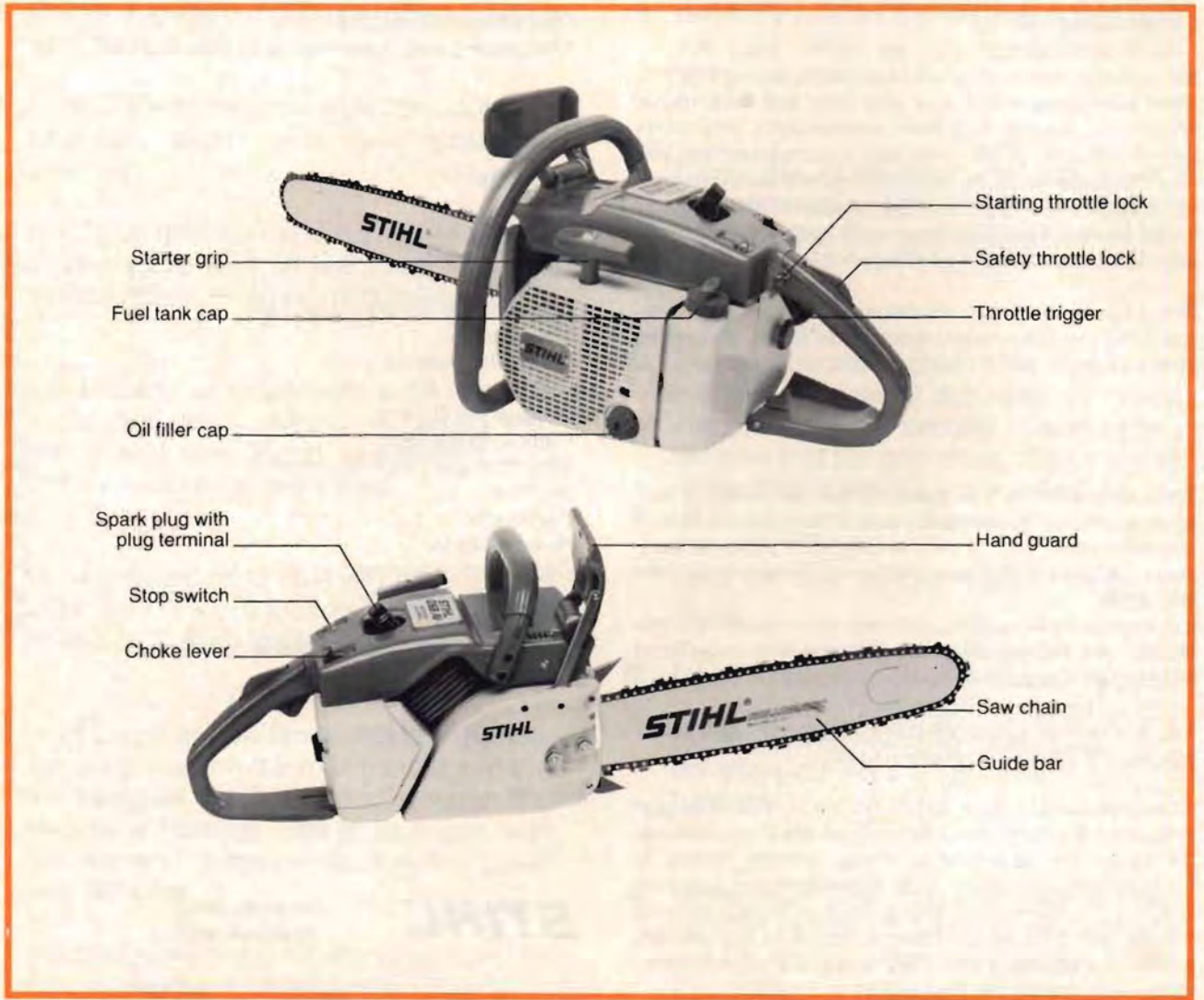

Fuel

Fuel tank cap open



Your two-stroke engine is powered by a mixture of gasoline and engine oil.

Only regular gasoline may be used. Never use high octane gasoline as it contains benzol which would permanently damage the carburetor diaphragms.

Only use STIHL two-cycle engine oil or other branded two-cycle engine oils for mixing. The mix ratio is 1:40 (1 part oil to 40 parts regular gasoline) with STIHL two-cycle engine oil or 1:25 for other branded engine oils.

Important: Always shake mixture in fuel can vigorously before fueling.

Chain Oil

Oil filler cap open



The service life of the cutting attachment (Oilomatic chain and guide bar) depends on good lubrication and the quality of the lubricating oil.

Never use waste oil for this purpose!

Always use the chain lubricating oil approved by STIHL and appointed dealers.

If special chain lubricating oil is not available, one of the high-duty, single grade engine oils listed below may be used in an emergency, depending on the outside temperature.

Outside temperature +10°C... +40°C: SAE 30
Outside temperature +10°C... -10°C: SAE 20
Outside temperature -10°C... -30°C: SAE 20 W or
SAE 10 W

Always top up with chain oil when you refuel. Carefully clean the area around the filler caps before opening and make sure that no dirt falls into the tank while you are refueling.

Mounting the Bar and Chain

Removing the chain sprocket cover



The guide bar and Oilomatic chain are supplied separately for safety reasons.

To mount them, first unscrew the two collar nuts (1) from the studs and take off the chain sprocket cover (2). If you have a Quickstop model, it is necessary to disengage the chain brake before taking off the sprocket cover; pull the hand guard back towards the handlebar. Now back off the chain tensioning nut (3) – behind inner side plate – by turning the tensioning screw (4) counterclockwise (to the left) to the end of its thread.

Fit the slot of the guide bar over the studs (5) so that the peg of the tensioning nut (6) engages in the lower locating hole (7).

Starting at the sprocket, fit the Oilomatic chain on the guide bar so that the cutting edges on the top of the bar are facing the bar nose.

Push the sprocket cover (2) onto the studs (5) and (on Quickstop models only) engage the end of the lever (8) in the slot on the hand guard.

4 Refit collar nuts (1) and screw them down finger-tight. Now

Top: Backing off tensioning nut
Center: Fitting chain on sprocket
Bottom: Peg in locating hole – cutting edges must face bar nose

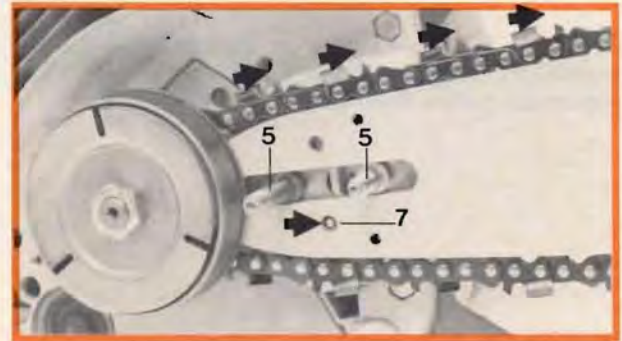
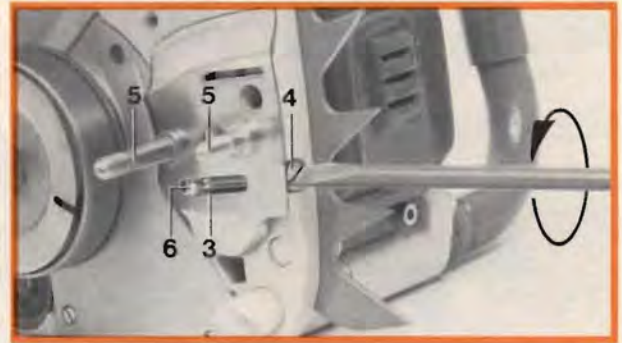

Top: Tensioning the chain
Bottom: Checking chain tension



tension the Oilomatic chain by turning the tensioning screw (4) clockwise and watching that the drive link tangs are properly located in the groove on the underside of the bar. Hold the bar up and turn tensioning screw (4) until the Oilomatic chain fits snugly against the underside of the bar. While still holding the bar nose up, tighten down the collar nuts (1) securely.

The Oilomatic chain is correctly tensioned when it fits snugly against the underside of the bar but can still be pulled easily along the bar by hand.

Chain Brake (Quickstop model only)

Chain brake engaged



The chain brake is actuated by means of the front hand guard.

Engaging the chain brake

When the hand guard is moved towards the nose of the guide bar the actuating lever automatically unlatches the brake lever and the spring-assisted brake band is clamped round the clutch drum at the same instant. This causes the saw chain to be brought to a standstill and locked in position.

Releasing the chain brake

The locked saw chain must be released before cutting can be continued. To do this, pull the hand guard back against the handlebar – this disengages the brake band from the clutch drum.

Important: Apart from starting and emergencies, the chain brake may be engaged only when the saw is idling. The chain brake is subject to normal wear. It is therefore necessary to have it regularly serviced and maintained by trained personnel (STIHL servicing dealer) to insure that it is always in good working order.

Safety Precautions



All safety precautions that are generally observed when working with an axe or a hand saw also apply to the operation of chain saws. However, because it is a fast-cutting power tool, there are additional safety precautions that must be observed.

If this is your first STIHL chain saw, have your dealer show you how to operate it, or attend a special course of training in the operation of power saws.

Observe all applicable local safety regulations, standards and ordinances.

Minors should not be allowed to use a chain saw. Children and animals should not be allowed in the area where a chain saw is in use. Never let the saw run unattended. Store it in a locked place away from children.

Do not lend your chain saw without the Owner's Manual. Be sure that anyone using your saw understands the information contained in this Manual.

6 There are three factors involved in the safe use of a chain saw: the operator, the saw and the use of the saw.



THE OPERATOR – physical condition and proper clothing

Your condition – You must be in good physical condition and mental health; and not under the influence of any substance (drugs, alcohol, etc.) which might impair vision, dexterity or judgment.

Working with any chain saw can be strenuous. If you have any condition that might be aggravated by strenuous work, check with your doctor before operating a chain saw.

Be alert – Avoid operating the chain saw when you are fatigued. If you become tired, take a break!

Your proper clothing – Clothing must be sturdy and snug-fitting, but allow complete freedom of movement.

Avoid loose-fitting jackets, scarfs, neckties, jewelry, flared or cuffed pants, or anything that could become entangled with the saw or brush.

Good footing is most important in chain saw work. Wear sturdy boots with non-slip soles. Steel-toed safety boots are recommended.



Heavy-duty, non-slip gloves improve your grip and protect your hands.

Proper eye protection is a must. Non-fogging, vented goggles or a face screen are recommended. Their use reduces the risk of eye injury.

Continuous exposure to the high noise levels involved in using a chain saw may cause hearing impairment. Protect your hearing with sound barriers, either ear plugs or noise-suppressing ear muffs.

Wear an approved safety hard hat to protect your head.

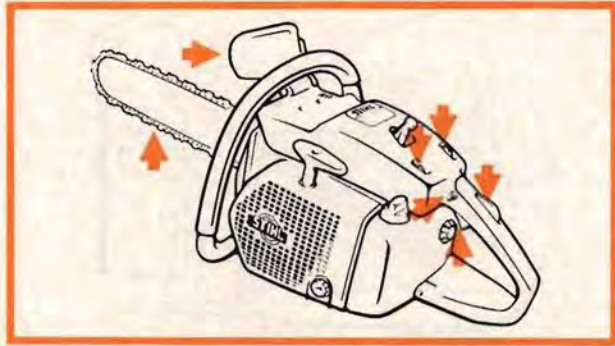

YOUR SAW

STIHL-Oilomatic-chain, guide bar and sprocket must match each other and the engine unit.

Attachments – Only attachments supplied by STIHL or expressly approved by STIHL for use with the specific STIHL saw models are authorized. Although certain unauthorized attachments are useable with the STIHL powerhead, their use may in fact be extremely dangerous.

Assembly – If your saw is not assembled at the time of purchase, see page 4 for instructions.

Inspection – You should always inspect your saw before starting it. Insure that bar and chain are securely mounted and properly tensioned. See page 4 for guide bar and chain mounting.

Make sure all the controls and safety devices (see illustration) are working properly. To reduce risk of injury, never operate a chain saw that is damaged, improperly adjusted or not completely and securely assembled.

Warning!

Never remove deactivate or tamper with any safety device on your saw.



Fueling – Your STIHL chain saw uses an oil-gasoline mixture for fuel (see page 3).

1. **Always** shut off the engine and allow it to cool before refueling. Remove fuel cap slowly to release possible fuel tank pressure.

Warning! Gasoline is a highly flammable fuel. Use extreme caution when handling gasoline or fuel mix. Do not smoke or bring any fire or flame near the fuel.

2. Select bare ground for fueling and move at least 10 feet (3 m) from fueling spot before starting the engine.
3. Fuel and operate your chain saw in wellventilated areas, outdoors only.
4. Wipe off any spilled fuel before starting your saw and check for leakage – also during operation.

Important! You should now understand the function of all the controls listed in figures page 7 – stop switch, throttle trigger, safety throttle lock, starting throttle lock, choke, Quickstop (if your saw was purchased with this option).

8

USE OF THE SAW

Starting – Your chain saw is a one-person saw. Start and operate your saw without assistance. For safety reasons always observe starting procedure described on page 19.

Warning!

At correct idle speed, chain should not turn. For directions to adjust idle speed, see page 26.

Do not use a saw with incorrect idle speed adjustment. Have your STIHL Dealer check it out and make proper adjustments or repairs.

After a saw with a **new chain** is started, switch engine off and recheck chain tension. Proper chain tension is very important at all times.

Warning!

Never touch a rotating chain with your hand or any part of your body.

To stop engine, move stop switch to “STOP” position.

Reactive forces, including kickback

Warning!

Reactive forces, including kickback can be dangerous! In any chain saw, the powerful force used to cut wood can be reversed (and work against the operator). If the rotating chain is suddenly stopped by contact with any solid object or a pinch, the reactive forces instantly occur. These reactive forces may result in loss of control which may, in turn, cause serious or fatal injury. An understanding of the causes of these reactive forces may help you avoid loss of control.

The most common reactive forces are kickback, pushback and pull-in:

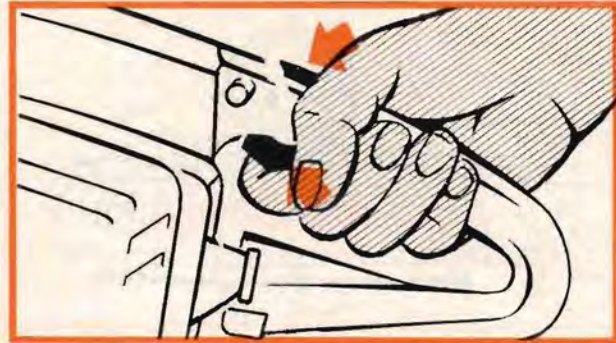
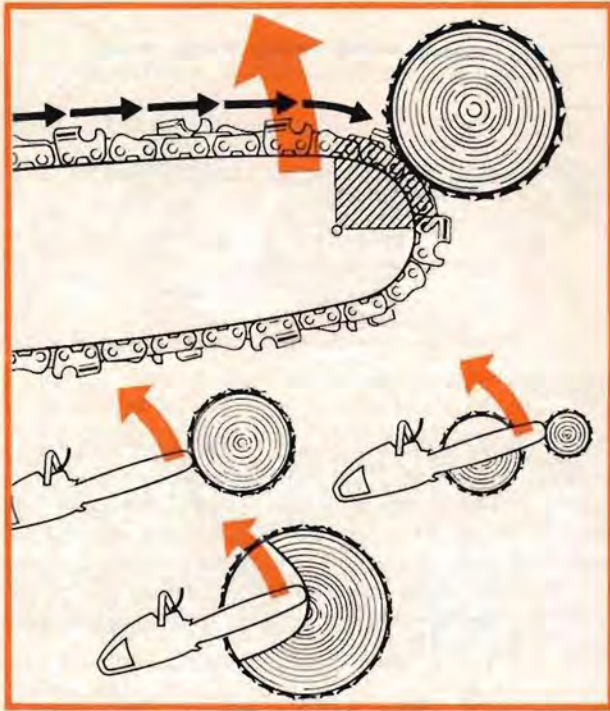

Kickback:

Kickback occurs when the nose of the bar and especially the upper quadrant contacts a solid object or is pinched. The chain is stopped, causing a rotational force in the opposite direction flinging the bar in an uncontrolled arc towards the operator, who may suffer severe or fatal injury. It most frequently occurs during limbing. It also occurs when the tip of the guide bar is pinched unexpectedly, unintentionally contacts solid material or is incorrectly used to begin a plunge or boring cut.



The best protection from personal injury that may result from kickback is to avoid kickback situations:

1. Be aware of the location of the guide bar nose during any cut.
2. Be alert for shifting of log or other forces that may cause the cut to close.
3. Use extreme caution when re-entering a previous cut.
4. Do not attempt plunge cuts or bore cuts if you are not experienced with these cutting techniques.
5. Never bring the tip of the bar in contact with any object.
6. Cut only one log at a time.
7. Begin cutting at full throttle.
8. Maintain saw chain properly. Cut with a correctly sharpened properly tensioned chain at all times.

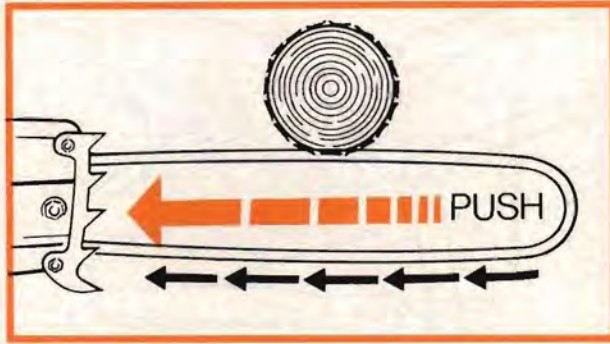

Pushback:

Pushback occurs when the chain on the top of the bar is suddenly stopped and the reaction drives the saw straight back toward the operator causing loss of saw control. It most frequently occurs when the top of the chain is pinched or caught in the cut or contacts a foreign object when the top of the bar is used for cutting.

To avoid pushback:

1. Be alert to forces or situations that may cause material to pinch the top of the chain.
2. Do not cut more than one log at a time.
3. Do not twist the saw when withdrawing the bar from a plunge cut or under buck because the chain can catch.

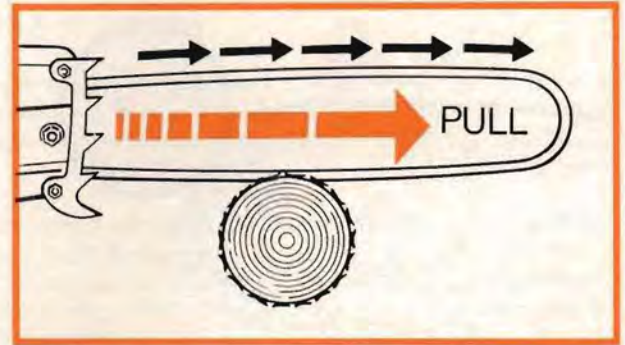

Pull-in:

Pull-in occurs when the bottom of the chain is suddenly stopped. The bottom of the chain stops when it is pinched, caught or encounters a foreign object in the wood. The reaction of the chain pulls the saw forward, causing the operator to lose control. Pull-in frequently occurs when the bumper spike of the saw is not held securely against the tree or limb and when the chain is not rotating at full speed before it contacts the wood.

To avoid pull-in, always start a cut with the chain rotating at full speed and the bumper spike in contact with the material. Pull-in may also be prevented by using wedges to open the kerf or cut.

To best counter any reactive forces, always maintain proper balance, secure footing, a firm grip on the saw and watch what and where you are cutting.

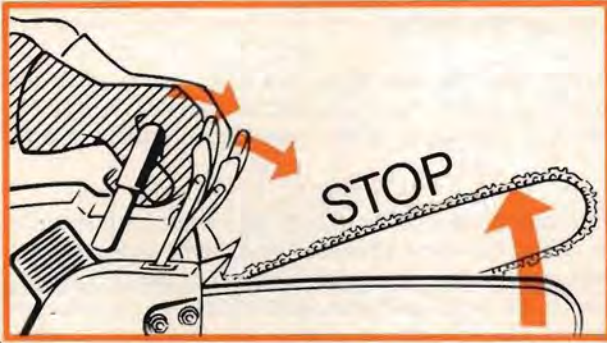

STIHL has developed a chain stopping system designed to reduce the risk of injury in a kickback situation. The device is called a Quickstop. The Quickstop is available on many STIHL saws. These devices do not prevent kickback, but will stop the chain in kickback situations if the operator's left hand is in position to activate the Quickstop.

When a kickback occurs, the bar of the saw rotates up and around the front handle. The left hand, when properly gripping the front handle engages the Quickstop lever. This activates the Quickstop and stops the chain (see illustration).

However, even if your saw has a "Quickstop", it does not guarantee that you will not be injured by a "kickback" and, therefore, you should observe all of the precautions to prevent kickback discussed previously.

Transporting your chain saw

By Vehicle: When transporting in a vehicle, keep bar and chain covered with a scabbard. Properly secure your saw to prevent turnover, fuel spillage and damage the saw.



By Hand: When carrying your saw by hand, the engine must be stopped, and the saw must be in the proper position. Grip the front handle and place the muffler at the side away from the body. The scabbard should be over the cutting attachment. When carrying your saw up-grade, the bar should be behind you. When carrying it down-grade, place the bar in front of you, so you won't slip and fall onto the saw.

Warning!

Carrying a chain saw with the engine running is extremely dangerous. Accidentally acceleration of the engine can cause the chain to rotate.

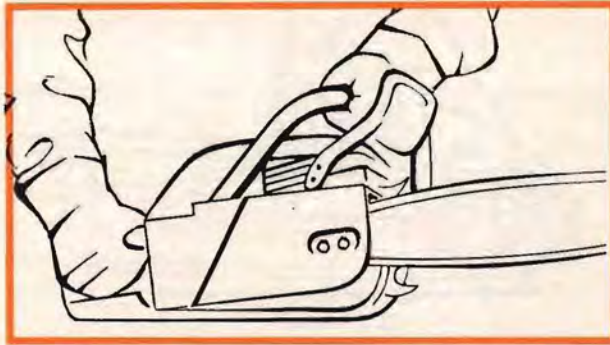

Cutting instructions

Always hold the saw firmly with both hands when the engine is running. Place your left hand on front handle bar and your right hand on rear handle and throttle control.

Wrap your fingers tightly around the handle bars, keeping the handle bar cradled between your thumb and forefinger. With your hands in this position, you can best oppose and absorb the push, pull and kickback forces of your saw without having it slip out of your grip. See page 9. Make sure your chain saw handle and grip are in good condition and free of moisture, pitch, oil or grease.

Warning!

1. Do not cut any material other than wood or wooden objects.
2. Use your chain saw for cutting only. It is not designed for prying or shoveling away limbs, roots or other objects.
3. When sawing, make sure that the saw chain does not touch any foreign materials such as rocks, nails and the like. Such objects may be flung off, damage the saw chain or cause the saw to kick back. Always maintain a firm foothold.

Warning!

Never work on a ladder, in a tree or on any other insecure support. Never use the saw overhead or with one hand.

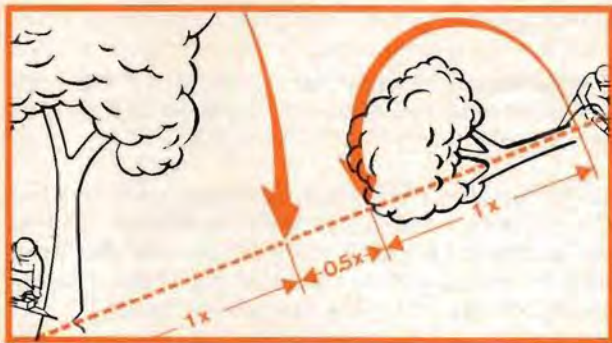

4. Position the chain saw in such a way that your body is clear of the cutting attachment. Stand to the left of cut while bucking (see illustration).

To reduce risks of injury all persons, including left-handers, should follow this instruction.

5. Do not try to do any felling or bucking unless you are trained in this work.
6. Operate the saw under good visibility and daylight conditions only. Work calmly and concentrate on your

job. Do not endanger other persons. Before felling, ascertain if anybody else may be endangered by the falling tree. Put off the work when the weather is windy, stormy or rainfall is heavy. Find some good shelter from falling limbs or trees under such conditions. Never operate a chain saw near another person.

When felling, maintain a distance of at least 2-1/2 tree lengths from the nearest person. **Note:** The noise of your engine may drown any warning call.

7. Use a strong, rigid saw horse when cutting thin wood, but do not have another person hold the material or assist in any other way. Never hold down the wood with your foot!

Do not cut limbs with the nose of the guide bar, as it may result in kickback. Be especially careful with small, tough limbs, which may easily catch the chain.

Before the saw begins to pinch, stop the engine and insert a wedge to open the cut. Use a tackle, rope winch or tractor, if necessary. Wedges should be of wood, light alloy or plastic – never of iron or steel, they can cause kickback and damage to the chain.

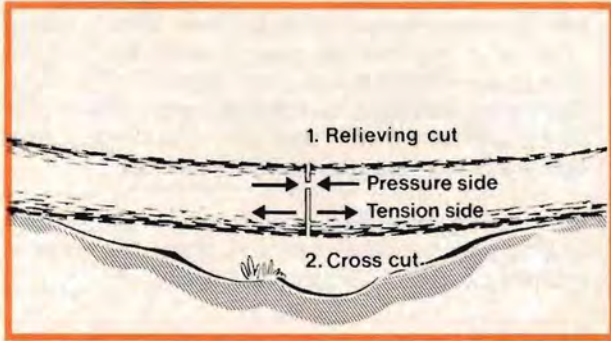
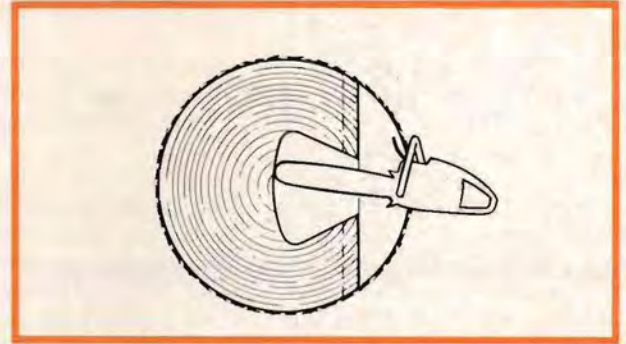
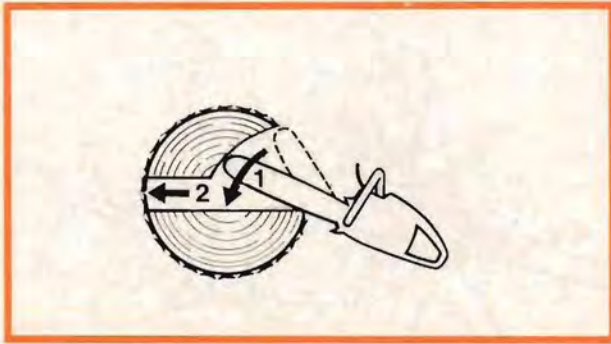

Plunge cut

Plunge cutting is done by starting the cut with the lower portion of the bar-tip and then moving in a straight forward path.

Plunge cuts with a chain saw are made primarily when using the heart-cut technique, if the log diameter is larger than double the length of the guide bar and also when felling oblique trees. They are also useful for strain relief in bucking. Plunge cutting requires extreme caution!

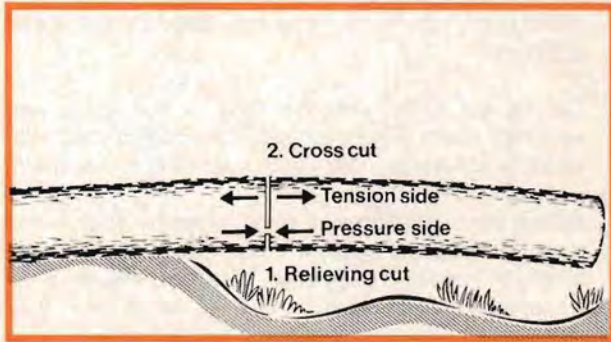

Apply the guide bar obliquely to the log rather than perpendicularly. Plunge in the guide bar nose until the bar penetrates the log by the double of its width. Then do the actual plunge cut. Keep the saw from kicking back.

Lying or standing timber under strain should be first cut at the compression side and then cut through the tension side. This is important to prevent the saw from pinching or kicking back.

Warning!

This cutting methods are extremely hazardous and should only be attempted by experienced cutters.

Special Precautions:

When felling, always keep to the side of the falling log. Then walk away sideways on a pre-planned safe escape and watch out for falling limbs (see page 16).

Take extreme care in wet and freezing weather (rain, snow and ice) and when working on slopes or uneven ground. When felling and bucking on a slope, the chain saw operator must stand on the up-hill side. Watch out for rolling logs. Increased danger of slipping exists on freshly debarked logs.

Avoid stumbling on obstacles such as stumps, roots or rocks and watch out for holes or ditches. Do not stand on a log while limbing it – you may slip or the log may roll. Do not underbuck freely hanging limbs. A pinch may result or the limb may fall, causing loss of saw control.

Be extremely careful with incompletely fallen trees and logs which are poorly supported. In such cases, set the saw aside and pull the tree down with a cable winch, block and tackle or tractor only. This is particularly true for “blow-down” areas where the logs, limbs and roots are tangled after heavy storms. Working in blowdown areas is severely hazardous. Drag the logs into a clear area before cutting. Pull out exposed and cleared logs first.

Warning! Only experienced woodcutters should work in blowdown areas.

Shattered wood should be cut very carefully. Sharp splinters of wood may be caught and flung in the direction of the operator of your saw.

When felling in the vicinity of roads, railways and power lines, etc., take extra precautions. Inform the police, utility company or railway authority before beginning to cut.





Before felling a tree, carefully determine the intended direction in which it is to fall. Check the natural lean of the tree, any unusually heavy limb structure, surrounding trees and obstacles. Clear the work area at the base of the tree. Then, establish a path of escape and remove all obstacles. This path should be opposite to the direction of the falling tree and at a 45° angle. An alternate path must also be selected. Place all tools and equipment a safe distance away from the tree, but not on the escape path.

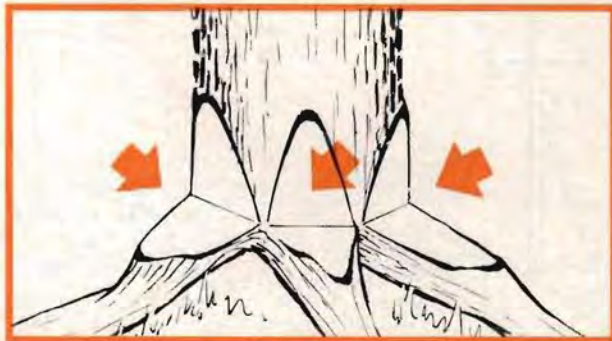

When the tree starts to fall shut off the power and quickly move away from the cutting area.

First clear the tree base and work area from interfering limbs and brush and clean its lower portion with an axe. Remove all dirt and pebbles, as they could dull the saw chain. The more thoroughly you clean it, the longer the chain will stay sharp. Then, determine the placement of the felling notch. If the tree has large buttress roots, cut into the largest buttresses vertically first (horizontally next) and remove; smaller ones may be removed later.

If you apply the first cut to the largest buttress, you will obtain uniformly high planes of cut. The first cut must be made low because too high buttresses may obstruct hauling later on.

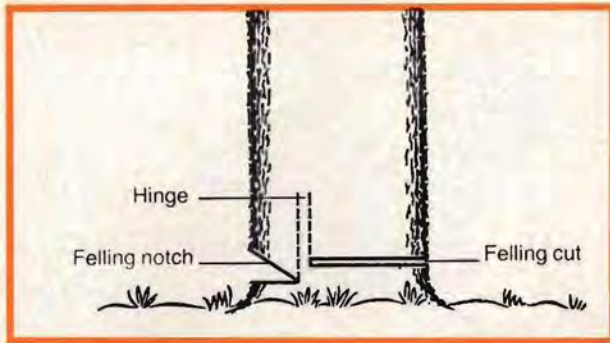

The felling notch is the first step that determines the direction in which the tree will fall. It is made at a right angle to the felling direction and should be as close to the ground as possible. Cut the felling notch to a depth of about one fourth of the trunk diameter. It should be in no case higher than it is deep. Make the felling notch very carefully.

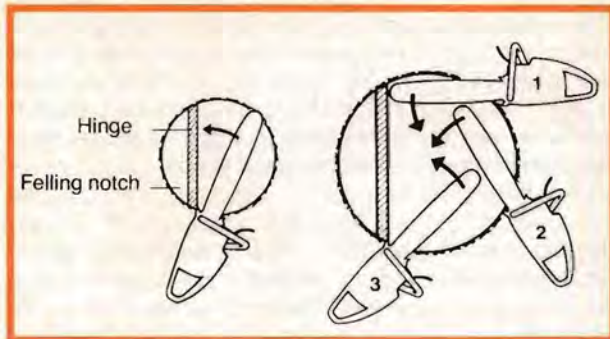

The next step is to make the so-called splint cut at either side of the log. These cuts are designed to prevent tearing of the splint wood when the log falls and are recommended for softwoods felled during the summer. Make the splint notches not deeper than one guide bar width and locate them at the same level as the intended felling cut.

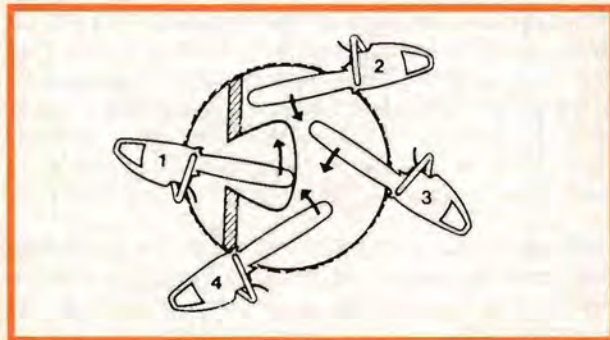

Begin the felling cut higher than the felling notch and proceed horizontally under all circumstances. For felling small trees, apply the chain saw with its spikes directly behind the uncut thickness of wood serving as a hinge and cut with a swing motion, so that the spikes contact the log one after the other. The uncut hingewood should be about one-tenth of the log diameter. Look for saw dust discoloration or easy cutting which indicate internal rot.

Do not cut through the uncut hingewood because you could lose control of the direction of the fall. Drive wedges into the felling cut where necessary to control the direction of the fall.

Warning! The following cutting methods are hazardous and should only be attempted by experienced cutters. When felling old timber with a diameter larger than the cutting length of the guide bar, reposition the saw using the sectioning method. Make the first cut with the guide bar fanning in towards the hinge wood. Use the spikes to act as a pivot and avoid repositioning the saw more often than absolutely necessary. When repositioning for the next cut, keep the guide bar fully engaged in the kerf to prevent the line of the felling cut from wandering off. For the last cut,

apply the chain saw directly behind the uncut band and swing it so the hinge wood is not cut. Make sure to move the saw around the log with the guide bar in a horizontal position.

If the log diameter is exceptionally large, a piece of heartwood may be left uncut. In such instances, make a heart-shaped cut by plunging the saw into the felling cut.

This technique can also be used with "problem" timber (oak or beech) to prevent tough heartwood from tearing and to ensure proper control of the felling direction. With deciduous woods, the heart cut is often performed too, in order to ease the stress in the log and to prevent splinters in the middle of the uncut band from being torn out.

Maintenance and Repair

Do not attempt any maintenance or repair work not described in the instruction manual. Have such work performed at your STIHL Service Shop. Always stop the engine before doing any service or repair work. **Warning!** Do not modify a chain saw in any way as this is dangerous.

Check the tank caps for tightness regularly and inspect the ignition cable and the spark plug connector. The spark plug should be the specified make and type. Check the A.V.-buffers and replace the buffers as a complete set only.

Check the condition of the muffler to prevent fires and excessive noise that could result in hearing loss. Use a spark arrestor type of muffler and do not touch it with your bare skin. Be aware of the hazard of forest fires, especially during the dry season.

Check the chain catching bolt for wear and replace it whenever it becomes damaged.

18



Observe the information given in the chain filing instructions (page 31) to ensure safe use and correct care of the saw chain and guide bar (page 22). A saw chain must always be in good condition, correctly sharpened, properly tensioned and well-lubricated. Cutter teeth must be of equal length, height, sharpness and shape.

Make sure that the depth gauges are properly and equally set and shaped to reduce kickback. A dull chain stretches more readily and is thrown off the guide bar more easily. Newly replaced chain links must be of the same make and type as the originals and must be filed down to the same shape and wear pattern as the remaining components. Make sure there are no cutter teeth missing. For the filing and repairing of a STIHL chain, use only recommended STIHL tools. Inspect the chain for cracks and broken parts regularly – a poorly maintained chain may cause kickback.

The engine must be shut off before checking and adjusting chain tension or changing a chain. Wear gloves when working with a saw chain or checking a saw chain for proper tension.

Starting

Chain brake engaged

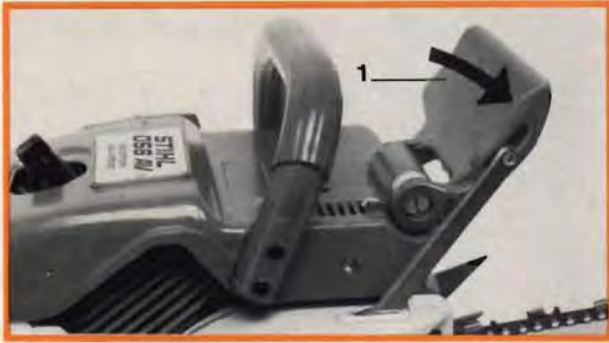

Start your saw without assistance of a second person. Keep other people clear of the general work area of the saw.

Place the chain saw on firm ground or other solid surface in an open area. Have a good balance and secure footing. Be absolutely sure that guide bar and chain are clear of you and all other obstruction and objects, including the ground. When engine starts (in start position), engine speed will be fast enough for the clutch to engage sprocket and turn the chain.

Starting procedure

1. Engage the chain brake on **Quickstop machines** by pushing the hand guard (1) toward the bar nose.
2. Move stop switch (2) away from "STOP".
3. **A cold engine** is started with the choke closed, slide choke lever (3) to "CHOKE".
A warm engine, or one that has only been stopped for a brief period, is started with the choke open – slide choke lever (3) away from "CHOKE".
4. Set throttle trigger to start position: Depress at first safety throttle lock (4), throttle trigger (5) and starting throttle lock (6). Next release throttle trigger (5) and then starting throttle lock (6).

Top: Stop switch away from "STOP"
Center: Choke lever in "CHOKE" position (cold-start)
Bottom: Choke lever away from "CHOKE" (warm-start)

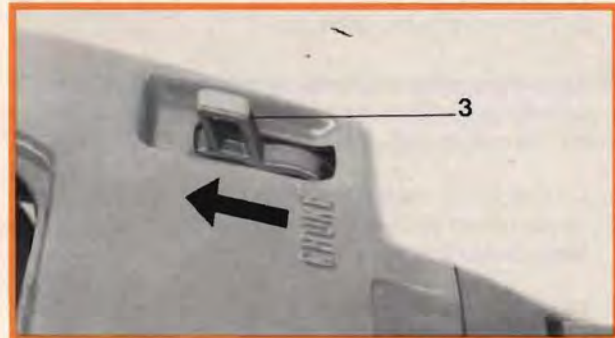
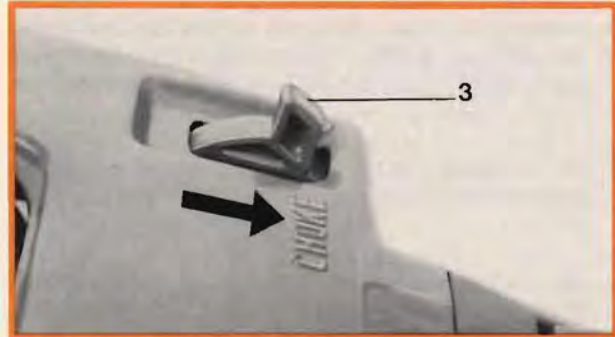

Starting-throttle position



Top: Starting
Center: Chain brake disengaged
Bottom: Stop switch in "STOP" position



5. To start the engine, hold saw firmly on the ground with your left hand around the handlebar (7) and put the toe of your right foot into the rear handle (8) and press down.

6. Pull out starter grip slowly with your right hand until you feel a definite resistance and then give it a brisk, strong pull.

The starter rope should not be pulled out more than 80 cm (30 in.) as there is otherwise a risk of it breaking.

Do not allow starter rope to snap back. Hold it vertically so that it can rewind correctly.

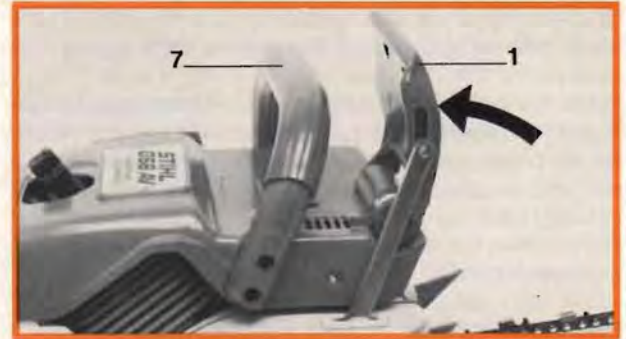

7. Once the engine is running, release the starting throttle lock (6) immediately by briefly squeezing the trigger so that the engine can settle down to idle speed.

8. On Quickstop models the chain brake has to be disengaged before you can start cutting – pull hand guard (1) back toward the handlebar (7).

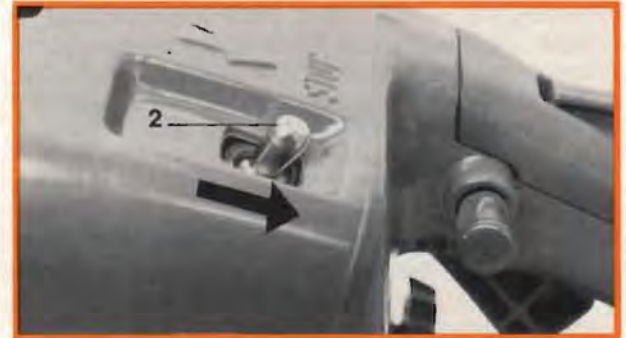

9. The engine is stopped by flicking the stop switch (2) to the "STOP" position.

Oil Quantity Control

Adjusting bolt at maximum position

Other points to be observed when starting the engine:

The choke lever is mechanically connected to the carburetor's choke valve. The choke valve is closed when the choke lever is on "CHOKE" and open when the choke lever is moved away from "CHOKE".

When starting a cold engine only keep the choke lever in the "CHOKE" position until the engine begins to fire. Then open choke fully – choke lever away from "CHOKE" – even if the engine stops and you have to repeat the starting procedure. If the choke lever is left in the "CHOKE" position, the combustion chamber will flood and stall the engine.

If you moved the choke lever away from the "CHOKE" position after the engine fired and the engine still does not run after several attempts, it is already flooded. In such a case, remove and dry off the spark plug. Clear the combustion chamber by cranking the engine over several times on the starter with the spark plug still removed and the stop switch in the "STOP" position. When you now try to start, move the choke lever away from "CHOKE" – even if the engine is cold – and set the throttle trigger to the starting-throttle position.

In very cold weather only open the choke slightly after starting – move choke lever to center position. Allow engine to warm up for a brief period at half-throttle. Then move choke lever away from "CHOKE" and disengage the starting-throttle lock.

A new engine or one which has been run until the fuel tank is dry will not start first time after fueling because the carburetor's diaphragm pump only delivers sufficient fuel after the engine has been turned over several times.



The oil quantity supply can be regulated with the adjusting bolt. It is positioned at the bottom side of the crankcase. By turning the adjusting bolt in clockwise direction to plus position (+) the lubricating quantity is increased, turning it anti-clockwise to minus position (–) the oil flow is decreased.

To assure sufficient lubricating quantity for the cutting tool at all times the adjusting bolt should always be set at plus position (+) – maximum oil supply. Only when using short guide bars decreasing of the lubricating supply is recommended.

If the oil supply has to be put out of function completely for instance when using an attachment tool put adjusting bolt to minus position (–) press in and turn further to "0" position.

Cutting Attachment

- 1 Oil inlet holes
- 2 Fixing holes

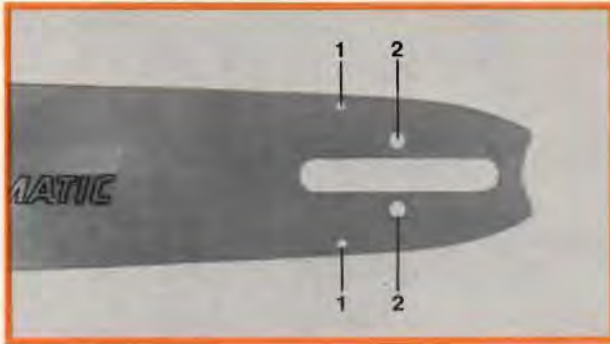

The cutting attachment of a chain saw consists of the guide bar, saw chain and chain sprocket.

Guide bar

The nose and underside of the guide bar are subjected to particular high stress and strain. To avoid one-sided wear, turn the guide bar over every time you sharpen or replace the chain. Regular cleaning of the oil inlet holes and the guide bar groove is also very important.

The guide bar can be examined for signs of wear at the same time. A minimum groove depth of 7 mm (0.28 in) must be maintained in order to avoid the drive link tangs scraping the bottom of the groove (the cutters and tie straps would not be able to run on the guide bar rails).

This depth should be measured at the spot where the bar is stressed most, i. e. the bar nose on Duromatic bars and the area with which most cutting is done on Rollomatic bars.

The guide bar must be replaced if the minimum depth cannot be maintained.

22

On Rollomatic bars the sprocket nose bearing must be greased regularly with the grease gun supplied with the bar. Under normal conditions it should be greased once daily. Only use high grade grease for refilling the grease gun, e. g. Refill Tube 0781 120 1111.

To grease the sprocket, place the saw on its side so that the bar nose is firmly supported. Clean the grease holes and then pump in the grease while slowly pulling the chain around the bar (sprocket turns) so that the bearing is uniformly filled. When grease emerges from the grease hole on the other side of the bar or around the sprocket, repeat the same procedure on the other side.

If the cutting attachment is used predominantly in wet conditions, e. g. cutting in snow, the sprocket nose should be greased more often. Moreover, to prevent corrosion the sprocket nose should be thoroughly greased from both sides after finishing work in order to force moisture out of the bearing.

Chain lubrication

Never operate your saw without chain lubricating oil. Check function of chain oiling system and oil level in the tank before starting work.

Hold chain saw with mounted cutting attachment over a light background. Take care, the Oilomatic chain must not touch the ground, i. e. keep it at least 20 cm (8 in) clear of the ground. Run the engine with half-throttle position. If an increasing patch of oil can be seen, chain lubrication is operating correctly.

Checking chain lubrication



Breaking in the Oilomatic chain

Every new chain has to be broken in for about 2 to 3 minutes. Ample chain lubrication is essential during this period. After breaking in, check chain tension and adjust if necessary.

Correct chain tension

The chain must always be slackened off after finishing cutting work. A chain properly tensioned when it is warm would, when the temperature drops, be subjected to such great contraction stresses that the chain would break and also damage the crankshaft and bearings.

The Oilomatic chain must, therefore, always be tensioned (with the engine shut off) before you start cutting. Chain tension is correct in the cold condition when the chain fits snugly on the underside of the bar and can still be pulled around the bar by hand – take care, the cutting edges are very sharp.

Worn chain sprocket



When the chain saw is operated in extremely cold weather a correctly cold-tensioned Oilomatic chain will begin to sag noticeably as it warms up to normal operating temperature. The chain must then be retensioned. However, it must be slackened off again **immediately** after you stop the saw. This is necessary to avoid contraction stress which would occur as the chain cools down to ambient temperature.

A new chain must be retensioned more frequently until it is fully stretched.

Chain sprocket

The stress and strain on the chain sprocket are particularly high. If the wear marks on the teeth are very pronounced (about 0.5 mm/0.02 in), the sprocket should be replaced. A worn sprocket reduces the service life of your saw chain. Replace the chain sprocket with every second Oilomatic chain. It is best to use two chains alternately with one sprocket.

Replacing the chain sprocket

On machines with chain brake

The chain brake must be disengaged before the chain sprocket cover can be removed – pull hand guard back toward handlebar.

First remove chain sprocket cover and bar and chain. Loosen and unscrew spark plug with combination wrench. Put clutch wrench through the slots of the outer cover plate between the clutch shoes. Turn crankshaft in such a way that the boring provided in the handle of the clutch wrench is in line with the bar stud and then insert the tube 1115 893 4200 through this boring onto the stud. Loosen crankshaft nut with a ring wrench SW 19.

Attention! Crankshaft nut and carrier have left hand thread – loosen in clockwise direction!

After unscrewing the nut remove outer guide washer, wrench and tube. Now screw locking screw into the cylinder by hand until it has a snug fit. Turn crankshaft in clockwise direction until the piston top rests against the locking nut, loosen and unscrew carrier with clutch wrench.

Now the inner guide washer, chain sprocket, needle cage and cover plate can be removed from the crankshaft.

Before reassembly clean butt end of crankshaft, wash needle cage in clean gasoline and apply ball bearing grease. Check drive pin in cover plate. If it is twisted insert a new one; a worn out boring must be replaced.

Top: Loosening the hexagonal nut
Bottom: Tightening the carrier (standard clutch)



Reassembling is done in reverse sequence of disassembly. When putting on the chain sprocket care must be taken that the drive pin engages into the boring of the chain sprocket. The beaded edge at the cover plate and at inner guide plate must point towards the crankcase. Tighten carrier with clutch wrench. Mount outer cover plate in such a way that the elevated area of the inner diameter points towards the carrier.

The crankshaft nut must be tightened down securely.

Air Filter

The function of the air filters is to keep back the dust of the sucked in air in order to reduce the wear of the driving parts.

Clogged air filters reduce the power of the engine, increase the fuel consumption and make starting more difficult.

The air filter must be cleaned daily – under extreme dust conditions more often!

Before removing clean the air filter and its surrounding area from dust. Close choke shutter – put choke lever to "CHOKE" position – so that no dust can drop into the carburetor. To remove the carburetor box cover turn lock to the left. Thereafter loosen the two slotted nuts in the air filter.

Now the air filter can be pulled from the studs.

For the daily cleaning it is sufficient to clean both filter parts with a soft brush.

However, once a week the complete air filter should be washed in clean gasoline and if possible cleaned with compressed air.

The reassembly is done in reverse sequence.

It is advisable to always carry a spare filter with you and to clean the clogged one at home.

Top: Loosening the slotted nut
Center: Remove carburetor box cover
Bottom: Removed filter



Carburetor

- 1 High speed adjustment screw
- 2 Low speed adjustment screw
- 3 Idle speed regulating screw

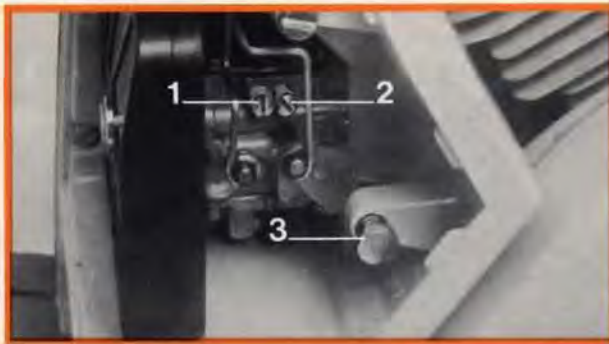

The carburetor has been adjusted at the factory for maximum performance and lowest fuel consumption under local average atmospheric conditions.

When working at high altitudes (mountains) or near sea level the carburetor must be readjusted. The adjustment must be made at the two adjustment screws and at the idle speed regulating screw.

For the basic adjustment – it should be taken as a guide for all readjustments – both adjustment screws are screwed in carefully until they have a snug fit. Thereafter the following adjustments have to be made:

High speed adjustment screw H: open $1\frac{1}{4}$ of a turn

Low speed adjustment screw L: open 1 of a turn

Never interchange the adjustment screws!

Carburetor adjustment must only be done while engine is warm and with clean air filter.

Regulating the idle speed regulating screw



Hints for readjustment of the carburetor

Engine stalls at idle speed:

With engine running turn idle speed adjusting screw slightly to the right – clockwise – (chain must not run).

Chain runs when engine is idling:

Turn idle speed adjustment screw slightly to the left anti-clockwise.

Engine speed erratic when idling:

Adjust low speed adjustment screw. You get a leaner mixture by turning it to the right – clockwise – and a richer mixture by turning it anti-clockwise.

Except for simple maintenance works repairs should be done by an authorized STIHL service shop. In many places you find service shops with all necessary tools and trained personell.

Starter Assembly

Remove the mounting screws



Top: Possible special knots
Bottom: Component parts of the starter assembly

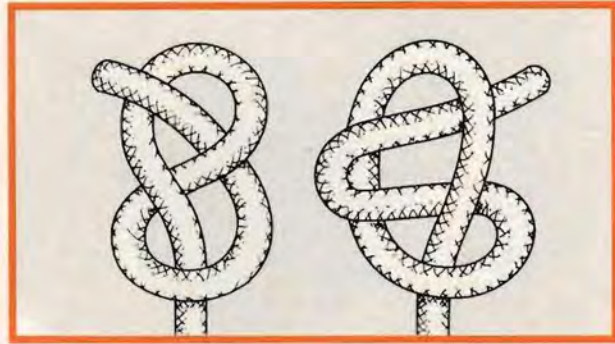

Replacing a broken starter rope

First remove the three screws which retain the fan housing. Next lift the base of the fan shroud away from the crankcase and slide downward and away from the engine.

Using a screwdriver, or a suitable pair of pliers, carefully remove the spring clip from the starter post groove. The rope rotor, together with the pawl can now be lifted off.

Remove any remaining rope from the rope groove in the rotor. Thread in a new starter rope, 4,5 mm (0.18 in) diameter and 1000 mm (40 in) long and secure it to the rope rotor with a simple overhand knot. Seal the ends of the rope to prevent ravelling with a match or lighter flame. Thread the other end of the rope through the rope guide hole in the fan housing from inside, pass it through the starter grip in an upward direction and secure it with a figure 8 or looped overhand knot (see diagram of knots). Do not rewind the rope on the rotor at this time. Clean and lubricate the rope rotor's bushing with a non-resinous oil, slide the rotor on the starter axle or post and align the rewind spring anchor loop (exposed through the center opening in the rewind spring housing) with the notched section of the rib on the

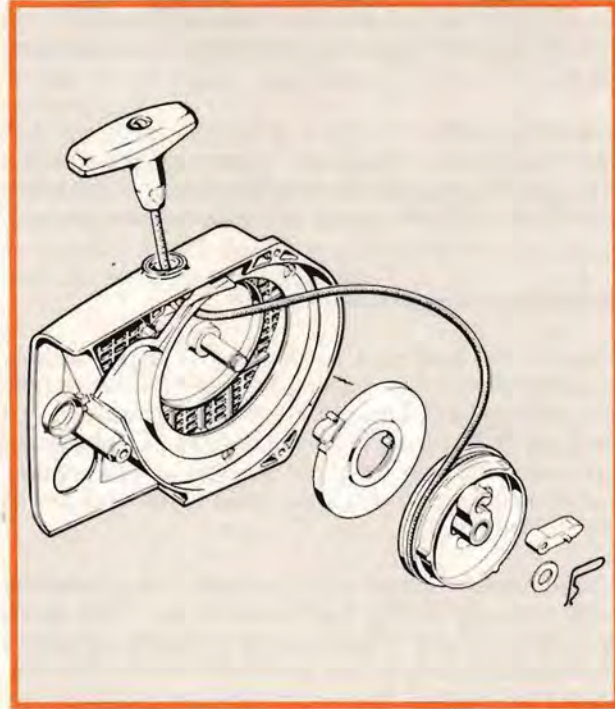

Installing the spring clip



back of the rope rotor. Rotate the rotor back and forth until the slotted area engages the starter rewind spring anchor loop.

Now insert pawl in rope rotor and press spring clip onto starter post with a suitable pair of pliers, making sure that the spring clip engages on the pawl's guide pin and points it in the clockwise direction. Then tension rewind spring.

Replacing a broken rewind spring

Remove the rope rotor as above. The spring housing together with the rewind spring can then be removed from the fan housing by turning the fan housing over and let it drop out of the recess in the fan housing. A replacement spring and spring housing are supplied as an assembly. Lubricate the spring with a few drops of non-resinous oil before installing it.

Drop the rewind spring/housing assembly (with the bottom plate area up) into the fan shroud recess. If the spring should pop out of its housing during installation re-insert it in its housing starting from outside to inside in counter-clockwise direction. Reassemble the rope rotor as above.

Tensioning the rewind spring



Tensioning the rewind spring

Rewind the starter rope by turning the rotor in counter-clockwise direction until the starter grip has reached a distance of about 20 cm (8 in) from the fan shroud. Form a loop in the remaining rope next to the rim of the rope rotor. Use this loop to turn the rope rotor clockwise by three full revolutions and hold the rope rotor in place by hand. Pull out and straighten the twisted rope. Gradually release the rope rotor and pull in the starter rope until it is fully re-wound on the rope rotor by spring force.

The rewind spring is tensioned correctly if the starter grip is held firmly in place against the starter housing by spring tension and does not droop. If more tension is required add one more turn on the rope rotor. The rope rotor should be able to be rotated by at least one-half an extra turn with the rope pulled all the way out. If spring tension is too great pull out the starter rope, hold the rotor firmly by hand, and remove one turn of the rope.

A rewind spring that is tensioned too heavily will probably break.

Re-install the fan shroud with the three retaining screws securely tightened.

General Maintenance

To increase the service life of the tool and to assure trouble-free operation few maintenance in regular intervals is necessary:

At the end of each working day clean the machine from saw dust and dirt. Also clean guide bar, saw chain and air filter. Make sure that the cutting tool is in proper operation condition.

Refill the fuel tank and store the tool in a dry place.

If you let your chain saw sit idle for a longer period you should additionally protect the engine against corrosion. While stopping the engine inject preservative oil through the carburetor.

You need not rinse the engine before starting again; just shake the fuel in the tank thoroughly. If engine does not start immediately spray some gasoline over the air filter.

After the break-in period of about 20–30 operating hours all screws and nuts of the tool except for the carburetor screws must be checked for tight seat and must be re-tightened.

The electrode gap of the spark plug is 0.5 mm (0.02 in) and should be checked with a feeler gauge from time to time and adjusted if necessary. If electrodes of the spark plugs are badly burned replace spark plugs.

Rinse fuel tank with clean gasoline every 50 operating hours. If necessary also clean strainer of the pick-up body.

Oil Inspection Window



To control the quantity of the chain lubricating oil and to clean the oil hose and pick-up body an oil inspection window is installed in the crankcase behind the chain sprocket cover.

Loosen oil inspection window with combi wrench and when removing take care that the gasket is not damaged. Now by means of a hook the oil inspection window with pick-up body can be removed for cleaning.

Specifications

Versions available

- 056 AVE; 056 AVSE: Electronic (breakerless) magneto ignition system
- 056 AVEQ; 056 AVSEQ: as 056 AVE, 056 AVSE but with chain brake

Engine

STIHL single cylinder two stroke engine

056

Piston displacement: 81 cm³ (4.94 cu. in)
Cylinder bore: 52 mm (2.05 in)
Piston stroke: 38 mm (1.5 in)

056 S

Piston displacement: 87 cm³ (5.3 cu. in)
Cylinder bore: 54 mm (2.13 in)
Piston stroke: 38 mm (1.5 in)

Ignition System 056 AV electronic

Principle: Electronic magneto ignition system (breakerless)
Ignition timing: 2.6 mm (0.1 in) before top dead center at 8000 r.p.m.
Spark plug: Bosch WSR 6 F or Champion RCJ 6 Y
Heat value 175
Electrode gap 0.5 mm (0.02 in)
Spark plug thread: M 14 x 1.25;
9.5 mm (0.37 in) length

Fuel System

Carburetor: All position diaphragm carburetor with integral fuel pump

Air filter:

Fuel tank capacity:

Fuel mixture:

Two part flat wire mesh filter
0.82 l (1.73 pt)
Mixture ratio 1:40 with STIHL engine oil;
1:25 for other branded two-stroke engine oils

Cutting Attachment

Guide bars:

Duromatic guide bars with stellite tipping at the bar head
Rollomatic guide bars with star shaped roller nose

Bar lengths:

Duromatic 40, 45, 50 and 63 cm (16, 18, 20 and 25 in)
Rollomatic 37, 40, 45, 50 and 63 cm (15, 16, 18, 20 and 25 in)

Oilomatic chain:

9.32 mm (3/8") Rapid-Standard, -Micro and -Super
Rapid-Standard and -Micro are also available as "S" (safety) chain
9.32 mm (3/8") Topic-Super

Chain sprocket:

7-tooth for 3/8" pitch

Chain lubrication:

Fully automatic oil pump, adjustable oil quantity control

Oil tank capacity:

0.36 l (0.76 pt)

Weight of saw

with 37 cm (14.5 in) bar and chain:
056 AVE; 056 AVSE 9.1 kg (20.06 lb)
056 AVEQ; 056 AVSEQ 9.5 kg (20.09 lb)

Sharpening and Maintenance of Saw Chain

Description of chains

STIHL saw chains are 3-link chains and all versions are assembled in the same basic pattern. The illustration on the right shows the component parts of a saw chain. Every chain manufactured by STIHL features the exclusive Oilomatic system. Apart from the three basic types (Rapid, Picco and Topic), there are three different versions whose names denote the cutter shape, i. e. chipper tooth = Standard, semi-chisel = Micro and full chisel = Super. Oilomatic Rapid chains are also available in standard and safety versions.

The main size measurement on a saw chain is the pitch. It is determined by measuring the distance from the center of one rivet to the center of the next rivet but one and dividing the measurement by two. The result is the pitch which, in accordance with international custom, is specified in inch ($\frac{3}{8}$ " = 9.32 mm).

Like any other cutting tool, the saw chain is subject to normal wear. A properly sharpened chain will eat into the wood and require very little effort on the part of the operator. For this reason alone you should never attempt to cut with a dull or damaged chain.

There are a few crucial angles which must be maintained in order to obtain good results when sharpening a chain. They are explained below.

Filing angle

The filing angle for Rapid-Standard and Rapid-Micro chains is 35°; these chains are initially sharpened to this angle before leaving the factory. However, if the chain is used primarily for cutting hardwood or frozen timber it is best to sharpen it to an angle of 30°. On the other hand, the filing angle for Rapid-Super and Topic-Super is always 30°.

Top: Component parts of Oilomatic Rapid chain
Bottom: Measuring chain pitch

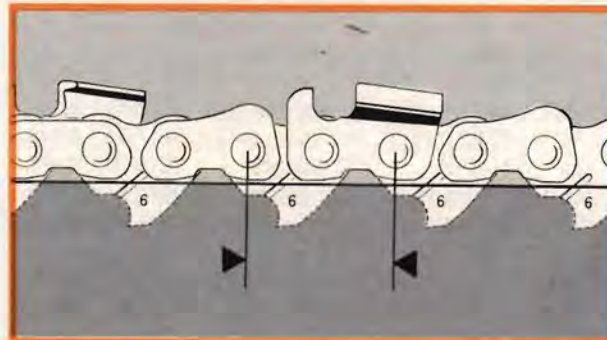
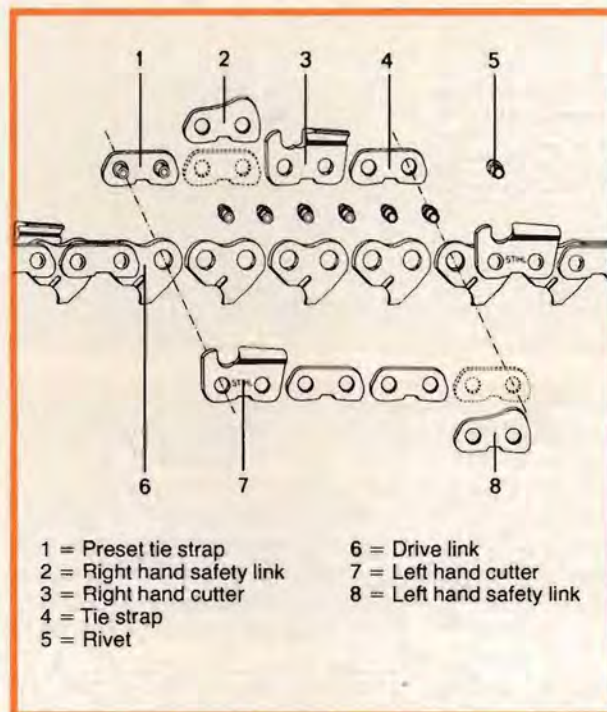

Top: Filing angle
 Center: 1-3 = Side plate angle
 4 = Top plate cutting angle
 Bottom: Table of file diameters

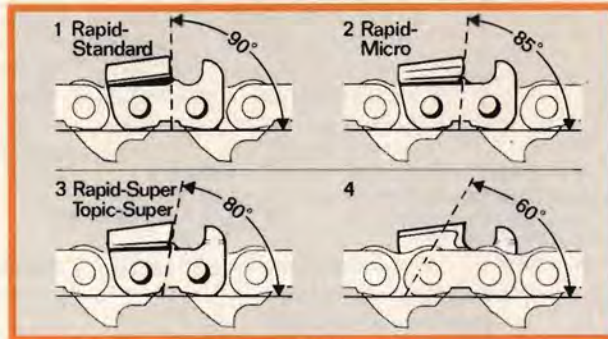
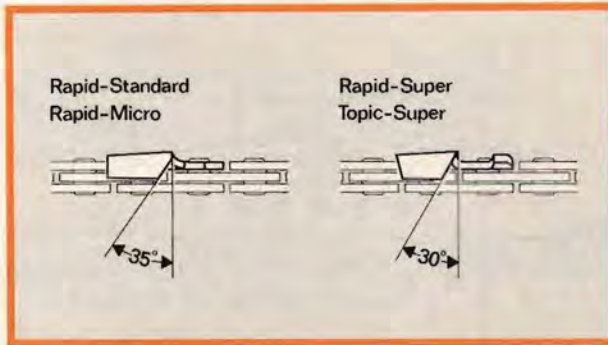

Chain pitch	File dia.	File No.
.325" (8.25 mm)	4.8 mm	0811 411 8088
3/8" (9.32 mm)*	5.5 mm	0811 411 8108
3/8" (Topic)	4.5 mm	6814 242 3396
.404" (10.26 mm)*	5.5 mm	0811 411 8108
1/2" (12.7 mm)	6.3 mm	0811 411 8118

* The 4.8 mm dia. round file must be used when the top plate has been filed back half-way.

It is essential to insure that the filing angle is kept exactly the same on all cutters. Irregular angles will cause the chain to run roughly and unevenly as well as increase the rate of wear and result in chain breakage. When sharpening by hand **always file from the inside to the outside of the cutting edge.**

Side plate angle

The upright cutting edge just below the top plate is known as the side plate cutting edge. The side plate angle is, therefore, the angle between the side plate cutting edge and the horizontal line formed by the cutter toe and heel. The specified side plate angles are 90° for Rapid-Standard, 85° for Rapid-Micro and 80° for Rapid-Super and Topic-Super chain. These angles are obtained automatically if a file holder is used with the correct file and the file is held correctly during sharpening.

Top plate cutting angle

The top plate cutting angle is 60° on all chains. It is also obtained automatically when the chain is sharpened carefully with a file holder or another STIHL sharpening tool.

Sharpening

Only special saw chain files may be used for sharpening and they must match the chain pitch. The shape and cut of machinists' files makes them unsuitable for saw chain. The special chain file should be used with a file holder or a filing tool.

All cutters must be filed to the same length. As the top plate slopes downward to the rear (clearance angle) the cutter

Top: File position for Rapid-Standard
Bottom: Sharpening with file holder

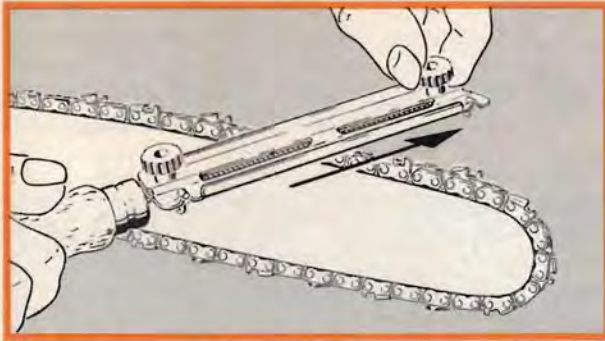
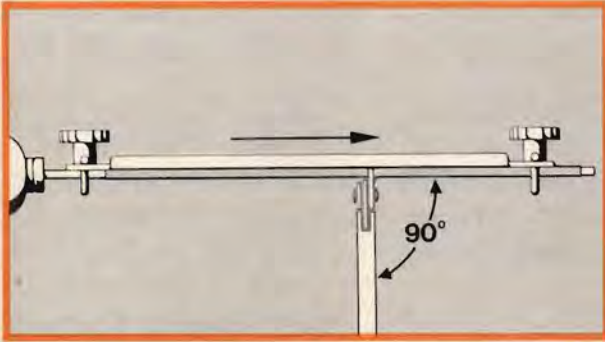

heights will be uneven if the cutter lengths are different. If the cutters are not all the same height the chain will run roughly and eventually break.

As it is very important to achieve uniform cutter lengths it is best to measure them with a slide caliper. Find and sharpen the shortest cutter first and then use it as a master for all the others, i.e. all cutters must be filed back to the same length as the master cutter. Sharpen all the cutters on one side of the chain first and then repeat the procedure on the other side.

File position for Rapid-Micro, Rapid-Super and Topic-Super

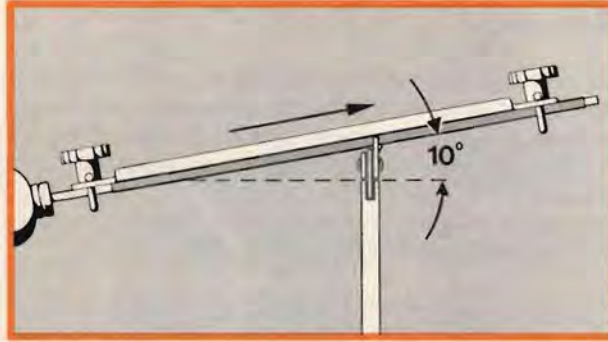

The file must be held level for **Rapid-Standard chain** so that it is at 90° to the perpendicular faces of the chain links.

On **Rapid-Micro, Rapid-Super and Topic-Super chains** the file and file holder must be guided so that the handle is 10° lower than the tip of the file, i.e. in this case the file must run upward at an angle of 10° to the horizontal. A file holder must always be used for manual sharpening of Rapid-Super and Topic-Super chains.

File evenly and steadily and note that the file **only sharpens on the forward stroke**. The file must be lifted off the cutter on the backstroke. Make sure that you do not touch the tie straps and drive links. Burrs on the cutting edge can be removed with a piece of hardwood.

Rotate the file at frequent intervals in order to prevent it becoming worn unevenly.

Important: Sharpen the chain frequently and take away as little material as possible. Two or three strokes of the file are usually sufficient to keep the chain sharp.

A STIHL electric sharpener greatly simplifies chain sharpening.

Depth gauges

The depth gauge determines the height at which the cutter enters the wood and thus the thickness of the chip removed. The cutting capacity and life of a saw chain are therefore influenced by the distance between the depth gauge and the cutting edge, i. e. the depth gauge setting. This setting varies according to chain pitch and must be checked with the appropriate filing gauge.

The best cutting results are obtained with the settings listed in the table on the right. However, the depth gauge setting may be increased by 0.2 mm for cutting softwood in mild weather conditions.

As the cutter is sharpened the depth gauge setting is reduced. This means the height of the depth gauge must be checked and lowered if necessary. If the depth gauge projects from the filing gauge, it must be filed down level with the gauge. On Rapid chain the depth gauge should also be rounded off to its original shape.

General chain maintenance

Chain maintenance begins as soon as the chain is fitted on the bar and sprocket. The essential points are **correct chain tension and ample lubrication**. See also "Cutting Attachment".

Clean the chain thoroughly in gasoline after sharpening in order to remove filings or grinding dust. Then lubricate the chain by immersing it in an oil bath. If the chain has not been used for an extended period, clean it with a brush and immerse it in an oil-paraffin bath.

Top: Table of recommended depth gauge settings
Center: Depth gauge setting
Bottom: Filing down depth gauge (Rapid chain)

Chain pitch	Setting	Filing gauge
.325" (8.25 mm)	0.65 mm	1110 893 4000
3/8" (9.32 mm)	0.65 mm	1110 893 4000
.404" (10.26 mm)	0.8 mm	1106 893 4000
1/2" (12.7 mm)	0.8 mm	1106 893 4000
090 G chain saw		
1/2" (12.7 mm)	1.2 mm	1106 893 4010

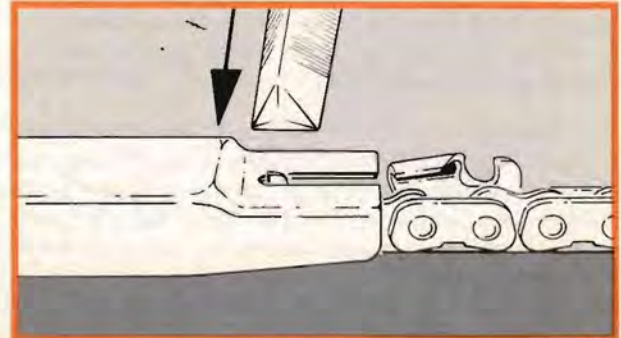
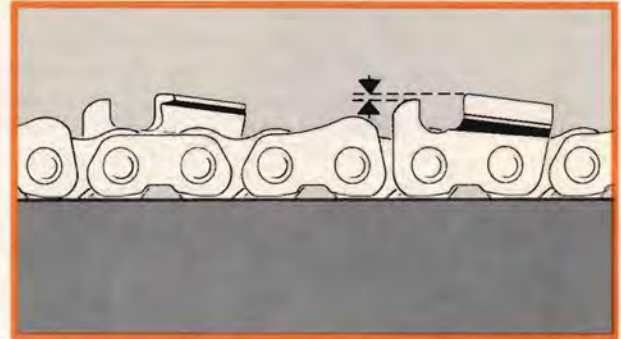

Top: Table of file holder order numbers
Bottom: STIHL file holder

Carefully examine chain for cracks in the links or damaged rivets while you are sharpening and cleaning it. Any damaged or worn parts must be replaced. The new parts must be reworked to match the shape and size of the original parts.

Chain breaking and riveting is best carried out with the STIHL rivet spinner.

Tools for chain maintenance

The **filing grid** has reference marks for the filing angle and is attached to the guide bar by means of a magnet.

File holders, which also have reference marks for the filing angle, simplify chain sharpening.

If you use the **STIHL-“Feilgenau”**, the **STIHL HOS** and **USG electric sharpeners** or the **STIHL rivet spinner**, always follow the separate operating instructions supplied with the tool.

Chain pitch	Chain	File holder
.325" (8.25 mm)	Rapid-Micro	5605 750 4325
.325" (8.25 mm)	Rapid-Super	5605 750 4340
3/8" (9.32 mm)	Rapid-Standard	5605 750 4330
3/8" (9.32 mm)	Rapid-Micro	5605 750 4330
3/8" (9.32 mm)	Rapid-Super	5605 750 4335
3/8" (9.32 mm)	Topic-Super	5605 750 4345
.404" (10.26 mm)	Rapid-Standard	5605 750 4330
.404" (10.26 mm)	Rapid-Micro	5605 750 4330
.404" (10.26 mm)	Rapid-Super	5605 750 4335

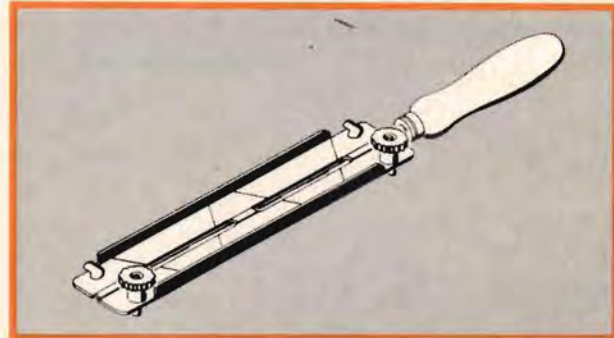

- 1 = for Micro and Picco
- 2 = for Standard
- 3 = for Super
- 4 = Standard, Micro and Picco filing angle

- 5 = Super filing angle
- 6 = Depth gauge setting
- 7 = Groove cleaner and scale for groove depth

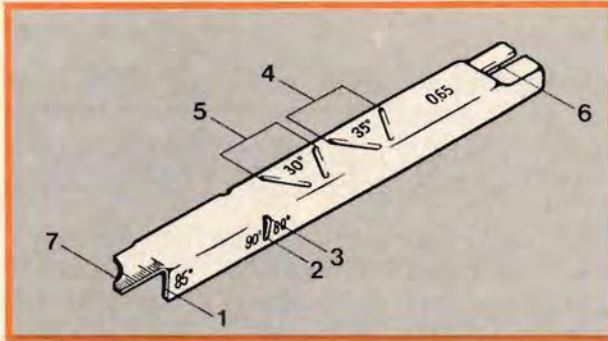

The **filing gauge** is a universal tool for checking the filing and side plate angles as well as the depth gauge setting and cutter length. It can also be used for cleaning the groove and oil inlet hole on the guide bar and measuring the groove depth.

- 1 = Sprocket pitch
- 2 = Chain pitch
- 3 = Drive link gauge
- 4 = Groove width

- 5 = Lug for cleaning bar groove and oil inlet hole

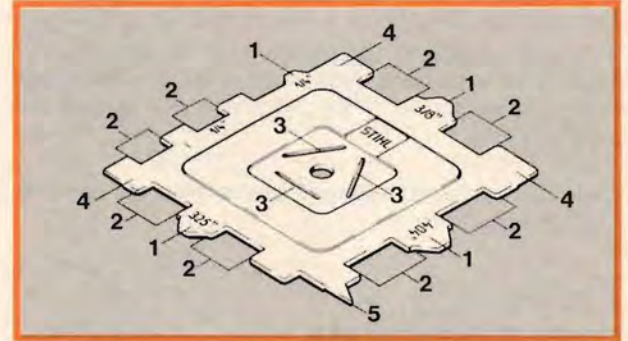

The **reference gauge 0000 893 4105** is used for measuring the pitch of the chain and sprocket as well as the drive link gauge on any chain. It is also provided with a lug for cleaning the bar groove and oil inlet hole.

Continuation of
Important Safety Precautions

14. Keep the handles dry, clean and free of oil or fuel mixture.
15. Operate the chain saw only in well ventilated areas.
16. Do not operate a chain saw in a tree unless specifically trained to do so.
17. **All** chain saw service, other than the items listed in the Owner's Manual maintenance instructions, should be performed by competent chain saw service personnel. (E.g., if improper tools are used to remove the flywheel, or if an improper tool is used to hold the flywheel in order to remove the clutch, structural damage to the flywheel could occur which could subsequently cause the flywheel to burst).
18. Avoid kickback. Kickback is the upward motion of the guide bar which occurs when the saw chain at the nose of the guide bar contacts an object. Kickback can lead to dangerous loss of control of the chain saw.

To avoid kickback:

- Hold the chain saw firmly with both hands.
 - Don't overreach.
 - Don't let the nose of the guide bar contact a log, branch, ground or any other obstruction.
 - Cut at high engine speeds.
 - Don't cut above shoulder height.
 - Follow manufacturer's sharpening and maintenance instructions for the saw chain.
 - Use devices such as low kickback chain, which may help to reduce the hazards associated with kickback.
19. When transporting your chain saw, use the appropriate guide bar scabbard.
 20. Narrow nose bars and low kickback chains are designed to reduce the risk of kickback injury. Ask your dealer about these devices.

englisch/english