

# STIHL 024

Instruction Manual  
Owner's Manual

Assembling  
Safety Precautions  
Operating Instructions  
Maintenance

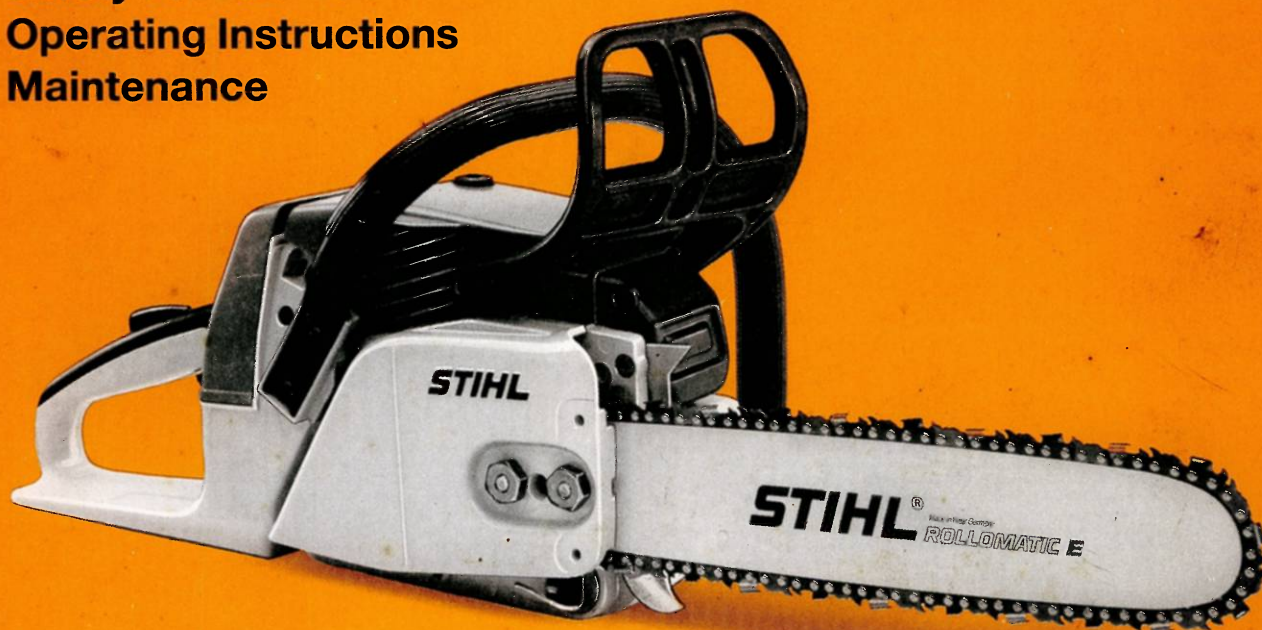

**Warning!**

Read and follow all safety precautions in Owner's Manual – improper use can cause serious or fatal injury.

To reduce risk of kickback injury use STIHL reduced kickback bar and STIHL PM 1 ( $\frac{3}{8}$ " Picco) or TM 1 (0.325") chain depending on sprocket pitch or other available low kickback components.

© Andreas Stihl 1985.

## Important Safety Precautions for Chain Saw Users

### A. Kickback Safety Precautions

#### Warning!

**Kickback** may occur when the nose or tip of the guide bar touches an object, or when the wood closes in and pinches the saw chain in the cut. Tip contact in some cases may cause a lightning fast reverse reaction, kicking the guide bar up and back towards the operator. **Pinching** the saw chain along the top of the guide bar may push the guide bar rapidly back towards the operator. Either of these reactions may cause you to lose control of the saw which could result in serious personal injury.

Section 4.12 of ANSI B 175.1-1985 sets certain performance and design criteria related to chain saw kickback. STIHL has developed a color code system using green and yellow to help you select a powerhead, bar and chain combination that complies with the kickback requirements of the ANSI Standard. See the sections entitled "Safety Precautions" and "Specifications" of this Manual.

Do not rely exclusively upon the safety devices built into your saw. As a chain saw user, you should take several steps to keep your cutting jobs free from accident or injury.

1. With a basic understanding of kickback, you can reduce or eliminate the element of surprise. Sudden surprise contributes to accidents.

2. Keep a **good** firm grip on the saw with both hands, the **right hand on the** rear handle, and the left hand on the **front handle**, when the engine is running. Use a **firm grip** with thumbs and fingers encircling the chain **saw handles**. A firm grip will help you reduce kickback and maintain control of the saw. Don't let go.
3. Make sure that area in which you are cutting is free from obstructions. Do not let the nose of the guide bar contact a log, branch, or any other obstruction which could be hit while you are operating the saw.
4. Cut at high engine speeds.
5. Do not overreach or cut above shoulder height.
6. Follow manufacturer's sharpening and maintenance instructions for the saw chain.
7. Only use replacement bars and chains specified by the manufacturer or the equivalent.

### B. Other Safety Precautions

1. Do not operate a chain saw when you are fatigued.
2. Use safety footwear; snug-fitting clothing; protective gloves; and eye, hearing, and head protection devices.
3. Use caution when handling fuel. Move the chain saw at least 10 feet (3 m) from the fueling point before starting the engine.

continued on the back inside cover →

# STIHL 024 AV Super electronic Quickstop, 024 WB electronic Quickstop

This Manual contains operating and safety instructions for all STIHL 024 series power saws.

Pay special attention to the safety precautions outlined on the inside cover and on pages 4 to 23. Allow only persons who understand this Manual to operate your chain saw.

To receive maximum performance and satisfaction from your STIHL chain saw, it is important that you read and understand the maintenance and safety precautions before using your saw. Contact your STIHL dealer or the STIHL distributor for your area if you do not understand any of the instructions in this Manual.

## Warning!

Because a chain saw is a high-speed wood-cutting tool, some special safety precautions must be observed as with any other power saw to reduce the risk of personal injuries. Careless or improper use may cause serious or even fatal injury.

STIHL's philosophy is to continually improve all of its products. As a result, engineering changes and improvements are made from time-to-time. If the operating characteristics or the appearance of your saw differs from those described in this Manual, please contact your STIHL dealer for information and assistance.

## Operating Instructions Sharpening and Maintenance of Saw Chains

### Contents

|   |    |
|---|----|
| Parts of the Chain Saw                  | 2  |
| Safety Precautions                      | 4  |
| – The Operator                          | 4  |
| – The Saw                               | 6  |
| – The Use of the Saw                    | 6  |
| – Maintaining and Storing the Saw       | 23 |
| Fuel                                    | 24 |
| Chain Oil                               | 25 |
| Mounting the Bar and Chain              | 26 |
| Chain Brake                             | 29 |
| General Notes on Operation              | 30 |
| Master Control                          | 31 |
| Starting                                | 32 |
| Electrically Heated Handles             | 35 |
| Winter Operation                        | 36 |
| Guide Bar, Chain and Sprocket           | 38 |
| Replacing the Chain Sprocket            | 40 |
| Air Filter                              | 41 |
| Carburetor                              | 42 |
| Rewind Starter                          | 44 |
| Maintenance Chart                       | 46 |
| Specifications                          | 47 |
| Sharpening and Maintenance of Saw Chain | 49 |
| Ordering Spare Parts                    | 55 |

## Parts of the Chain Saw

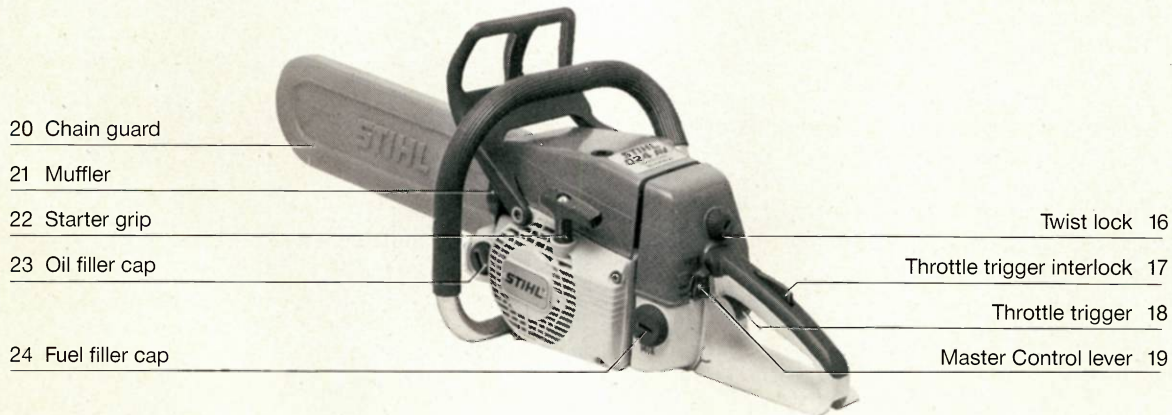
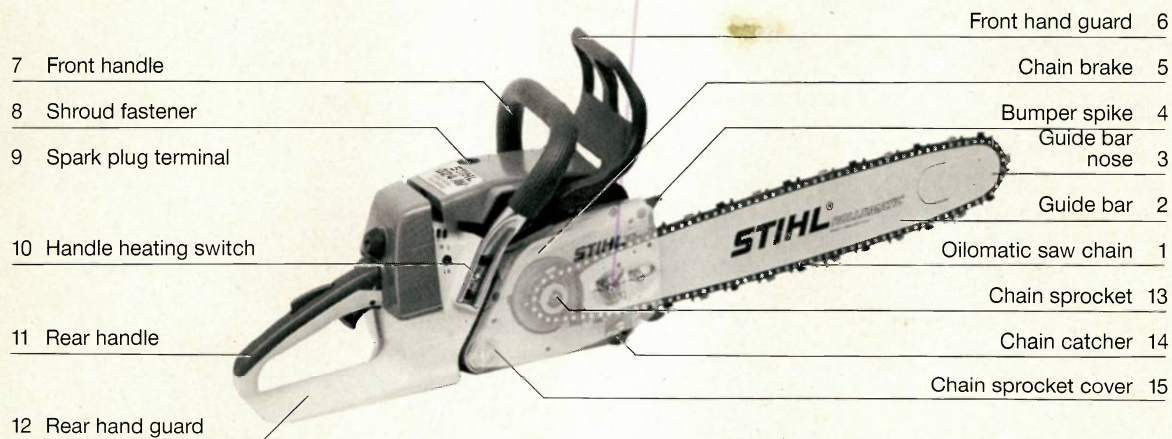

## Definitions

1. **Oilomatic Saw Chain.** A loop consisting of cutters, tie straps and drive links.
2. **Guide Bar.** Supports and guides the saw chain.
3. **Guide Bar Nose.** The exposed end of the guide bar.
4. **Bumper Spike.** Toothed stop for holding saw steady against wood.
5. **Chain Brake.** A device to stop the rotation of the chain if activated in a kickback situation by the operator's hand or by inertia.
6. **Front Hand Guard.** Provides protection against projecting branches and helps prevent the left hand from touching the chain if it slips off the handle bar.
7. **Front Handle.** Handle bar for the left hand at front of saw.
8. **Shroud Fastener.** For fastening the shroud.
9. **Spark Plug Terminal.** Connects the spark plug with the ignition wire.
10. **Handle Heating Switch.** For switching the electric handle heating on and off.
11. **Rear Handle.** The support handle for the right hand, located at or toward the rear of the saw.
12. **Rear Hand Guard.** Gives added protection to operator's right hand.
13. **Chain Sprocket.** The toothed wheel that drives the saw chain.
14. **Chain Catcher.** Helps to reduce the risk of operator contact by a chain when it brakes or comes off the bar.
15. **Chain Sprocket Cover.** Covers the clutch and the sprocket.
16. **Twist Lock.** Lock for carburetor box cover.
17. **Throttle Trigger Interlock.** Must be depressed before the throttle trigger can be activated.
18. **Throttle Trigger.** Controls the speed of the engine.
19. **Master Control Lever.** Lever for choke control, starting throttle, run and stop switch, position.
20. **Chain Guard (Scabbard).** Covers the bar and the chain when the saw is not in use.
21. **Muffler.** Reduces engine exhaust noise and directs the exhaust gases.
22. **Starter Grip.** The grip of the starter, for starting the engine.
23. **Oil Filler Cap.** For closing the oil tank.
24. **Fuel Filler Cap.** For closing the fuel tank.

**Clutch.** Couples engine to chain sprocket when engine is accelerated beyond idle speed.  
(Not illustrated.)

**Anti-Vibration System.** The anti-vibration system includes a number of buffers designed to reduce the transmission of vibrations created by the engine and cutting attachment to the operator's hands.  
(not illustrated).

## Safety Precautions

The use of any chain saw may be hazardous. The saw chain has many sharp cutters. If the cutters contact your flesh, they will cut you, even if the chain is not moving. At full throttle, the chain speed can reach 45 mph (20 m/s). It is important that you read, fully understand and observe the following safety precautions and warnings. Read the owner's manual **and** the safety instructions periodically.

Pay special attention to the section on reactive forces, pages 10 to 16.

### Warning!

Reactive forces, including kickback, can be dangerous. Careless or improper use of any chain saw may cause serious or fatal injury.

All safety precautions that are generally observed when working with an axe or a hand saw also apply to the operation of chain saws. However, because a chain saw is a highspeed, fast-cutting power tool, special safety precautions must be observed to reduce the risk of personal injury.

Have your STIHL dealer show you how to operate your chain saw. Observe all applicable local safety regulations, standards and ordinances.

### Warning!

Minors should never be allowed to use a chain saw. Bystanders, especially children and animals should not be allowed in the area where a chain saw is in use (ill. 1). Never let the saw run unattended. Store it in a locked place away from children and empty the fuel tank before storing for longer than a few days.

Do not lend or rent your chain saw without the Owner's Manual. Be sure that anyone using your saw reads and understands the information contained in this Manual.



These safety precautions and warnings apply to the use of all STIHL chain saws. Different models may have different parts and controls. See the appropriate section of your Owner's Manual for a description of the controls and function of the parts of your model saw.

Safe use of a chain saw involves

1. the operator
2. the saw
3. the use of the saw.

## THE OPERATOR

### Physical Condition

You must be in good physical condition and mental health and not under the influence of any substance (drugs, alcohol) which might impair vision, dexterity or judgment.

Do not operate a chain saw when you are fatigued (ill. 2). Be alert – If you get tired while operating your chain saw, take a break. Tiredness may result in loss of control. Working with any chain saw can be strenuous. If you have any



condition that might be aggravated by strenuous work, check with your doctor before operating a chain saw.

### Warning!

Prolonged use of chain saws (or other machines) exposing the operator to vibrations may produce whitefinger disease (Raynaud's phenomenon). This phenomenon reduces the hand's ability to feel and regulate temperature, produces numbness and burning sensations and may cause nerve and circulation damage and tissue necrosis.

Many STIHL models are available with an anti-vibration (AV) system designed to reduce engine vibration. An anti-vibration system is recommended for those using chain saws on a regular or sustained basis.

Heated handles help to reduce the risk of whitefinger disease and are recommended for cold weather use. Most STIHL powerheads are available with heated handles.

Anti-vibration systems and heated handles do not guarantee that you will not sustain whitefinger disease. Therefore, continual and regular users should monitor closely the condition of their hands and fingers. If any of the above symptoms appear, seek medical advice immediately.

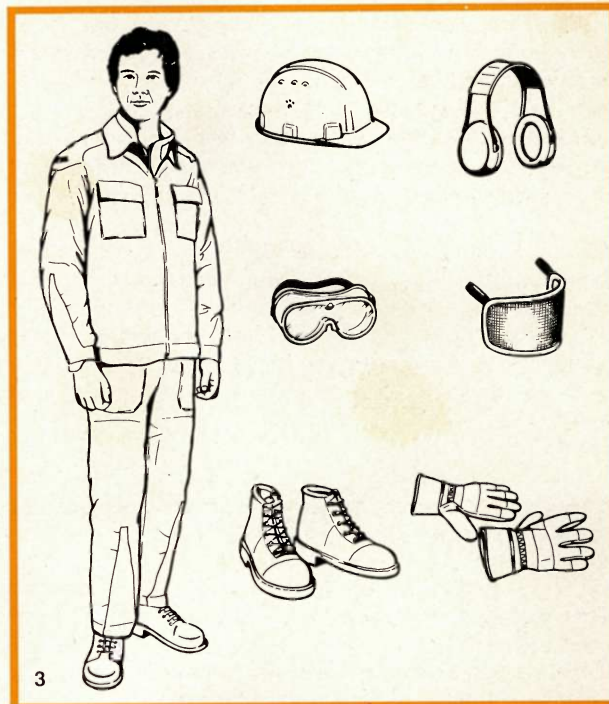

### Proper Clothing

Clothing must be sturdy and snug-fitting, but allow complete freedom of movement. Avoid loose-fitting jackets, scarfs, neckties, jewelry, flared or cuffed pants, or anything that could become entangled with the saw or brush. Wear overalls or jeans with a reinforced cut resistant insert (ill. 3).

Protect your hands with gloves when handling saw and saw chain. Heavy-duty, nonslip gloves improve your grip and protect your hands.

Good footing is most important in chain saw work. Wear sturdy boots with nonslip soles. Steel-toed safety boots are recommended.

Proper eye protection is a must. Non-fogging, vented goggles or a face screen is recommended. Their use reduces the risk of eye injury.

Wear an approved safety hard hat to protect your head. Chain saw noise may damage your hearing. Always wear sound barriers (ear plugs or ear muffs) to protect your hearing. Continual and regular users should have their hearing checked regularly.

## THE SAW

Parts of the chain saw; for illustrations and definitions of the parts see pages 2 and 3!

### Warning!

Never modify a chain saw in any way. Only attachments and parts supplied by STIHL or expressly approved by STIHL for use with the specific STIHL saw models are authorized. Although certain unauthorized attachments are useable with the STIHL powerhead, their use may, in fact, be extremely dangerous.

## THE USE OF THE SAW

### Transporting the chain saw

### Warning!

Always stop the engine before putting a chain saw down or carrying it. Carrying a chain saw with the engine running is extremely dangerous. Accidental acceleration of the engine can cause the chain to rotate. During operation,



the powerhead muffer and the material around it reach extremely high temperatures. Avoid touching the hot muffer, you could receive serious burns.

**By hand:** When carrying your saw by hand, the engine must be stopped and the saw must be in the proper position. Grip the front handle and place the muffer away from the body (ill. 4).

The chain guard (scabbard) should be over the chain and the guide bar, which should point backwards. When carrying your saw, the bar should be behind you (ill. 4).

**By vehicle:** When transporting in a vehicle, keep chain and bar covered with the chain guard. Properly secure your saw to prevent turnover, fuel spillage and damage to the saw.

### Preparation for the use of the saw

Take off the chain guard and inspect for safety in operation. For assembly, follow the procedure described in the chapter "Mounting the Bar and Chain" of your owner's manual.



STIHL Oilomatic chain, guide bar and sprocket must match each other in gauge and pitch.

Before replacing any bar and chain, see the sections on "Specifications", kickback and the ANSI B 175.1-1985 chain saw kickback standard in this manual.

### Warning!

Proper tension of the chain is extremely important. In order to avoid improper setting, the tensioning procedure must be followed as described in your manual. Always make sure the hexagonal nut(s) for the sprocket cover is (are) tightened securely after tensioning the chain. Never start the saw with the sprocket cover loose. Check chain tension once more after having tightened the nut(s) and thereafter at regular intervals (whenever the saw is shut off). If the chain becomes loose while cutting, shut off the engine and then tighten. Never try to tighten the chain while the engine is running!

### Fueling

Your STIHL chain saw uses an oil-gasoline mixture for fuel (see chapter "Fuel" of your owner's manual).

### Warning!

Gasoline is an extremely flammable fuel. Use extreme caution when handling gasoline or fuel mix. Do not smoke or bring any fire or flame near the fuel (ill. 5).

### Fueling Instructions

Fuel your chain saw in well-ventilated areas, outdoors only.

Always shut off the engine and allow it to cool before refueling. Gasoline vapor pressure may build up inside the gas tank of a two cycle engine depending on the fuel used, the weather condition, and the venting system of the

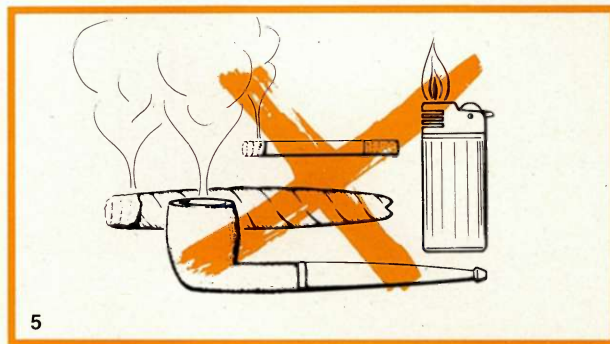

tank. In order to reduce the risk of burns or other personal injury from escaping gas vapor and fumes, remove the gas cap on the STIHL product carefully so as to allow any pressure build-up in the tank to release slowly. Never remove fuel filler cap while engine is running.

Select bare ground for fueling and move at least 10 feet (3 m) from fueling spot before starting the engine. Wipe off any spilled fuel before starting your saw, and check for leakage.

Check for fuel leakage while refueling and during operation. If fuel or oil leakage is found, do not start or run the engine until leak is fixed and spilled fuel has been wiped away. Tighten the fuel cap after filling to avoid spillage and risk of fire.

### Starting

#### Warning!

Your chain saw is a one-person saw. Do not allow other persons to be near the running chain saw. Start and operate your saw without assistance. For specific starting instructions, see the appropriate section of the owner's manual. Proper starting methods reduce the risk of injury.



Do not drop start. This method is very dangerous because you may lose control of the saw (ill 6).

There are two recommended methods for starting your chain saw. With the **first method**, the chain saw is started on the ground. Engage the chain brake (see "Chain Brake" chapter in your owner's manual) and place the chain saw on firm ground or other solid surface in an open area. Maintain good balance and secure footing. Grip the front handlebar of the saw firmly with your left hand and press down. For saws with a rear handle level with the ground, put the toe of your right foot into the rear handle and press down. With your right hand pull out the starter grip slowly until you feel a definite resistance and then give it a brisk, strong pull.

The **second** recommended **method** for starting your chain saw allows you to start the saw without placing it on the ground. Engage the chain brake, grip the front handle of the chain saw firmly with your left hand. Keep the arm on the front handle in a locked (straight) position. Hold the rear handle of the saw tightly between your legs just above the knees. Maintain good balance and secure footing. Pull the starting grip slowly with your right hand until you feel a definite resistance and then give it a brisk, strong pull.

### Warning!

Be sure that the guide bar and chain are clear of you and all other obstructions and objects, including the ground. When the engine is started, the engine speed with the starting throttle lock engaged will be fast enough for the clutch to engage the sprocket and turn the chain. If the upper quadrant of the tip of the bar touches any object, it may cause kickback to occur (see section on reactive forces on pp. 10–16). To reduce this risk, always engage the chain brake before starting. Never attempt to start the chain saw when the guide bar is in a cut or kerf.

When you pull the starter grip, do not wrap the starting rope around your hands. Do not allow the grip to snap back, but guide the starter rope slowly back to permit the rope to rewind properly. Failure to follow this procedure may result in injury to hand or fingers and may damage the starter mechanism.

### Important adjustments

#### Warning!

At correct idle speed, the chain should not rotate. For directions to adjust idle speed, see the appropriate section of your owner's manual.

Do not use a saw with incorrect idle speed adjustment.

If you cannot set the correct idle speed, have your STIHL dealer check your saw and make proper adjustments or repairs.

After adjusting a chain, start the saw, let the engine run for a while, then switch engine off and recheck chain tension. Proper chain tension is very important at all times.

## Working Conditions

Operate your chain saw only outdoors in a ventilated area. Operate the saw under good visibility and daylight conditions only.

Don't work alone. Keep within calling distance of others in case help is needed.

Your chain saw is equipped with a chain catcher. It is designed to reduce the risk of personal injury in the event of a thrown or broken chain. From time to time the catcher may be damaged or removed. To reduce the risk of personal injury, do not operate a chain saw with a damaged or missing catcher.

Inspect buffers periodically. Replace damaged, broken or excessively worn buffers immediately, since they may result in loss of control of the saw. A "sponginess" in the feel of the saw, increased vibration or increased "bottoming" during normal operation may indicate damage, breakage or excessive wear. Buffers should always be replaced in sets. If you have any questions as to whether the buffers should be replaced, consult your STIHL servicing dealer.

### Warning!

Take extreme care in wet and freezing weather (rain, snow, ice). Put off the work when the weather is windy, stormy or rainfall is heavy. Clear the area where you are working.

### Warning!

Avoid stumbling on obstacles such as stumps, roots or rocks and watch out for holes or ditches. Be extremely cautious when working on slopes or uneven ground. There is increased danger of slipping on freshly debarked logs.

## Cutting Instructions

**Grip:** Always hold the saw firmly with both hands when the engine is running. Place your left hand on front handle bar and your right hand on rear handle and throttle trigger. Left-handers should follow these instructions too.

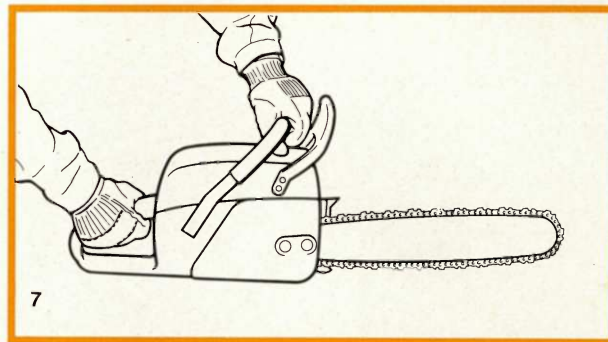

Wrap your fingers tightly around the handles, keeping the handles cradled between your thumb and forefinger (ill. 7). With your hands in this position, you can best oppose and absorb the push, pull and kickback forces of your saw without losing control (see section on reactive forces). Make sure your chain saw handles and grip are in good condition and free of moisture, pitch, oil or grease.

### Warning!

To reduce the risk of serious or fatal injury to the operator or bystanders, never use the saw with one hand. You cannot control reactive forces (see pages 10 to 16), and you may lose control of the saw, which can result in the skating or bouncing of the bar and chain along the limb or log.

Even for those compact saws designed for use in confined spaces, one-handed operation is dangerous because the operator may lose control.

### Warning!

Do not operate your chain saw with the starting throttle lock engaged. Cutting with the starting throttle lock engaged does not permit the operator proper control of the saw or chain speed.

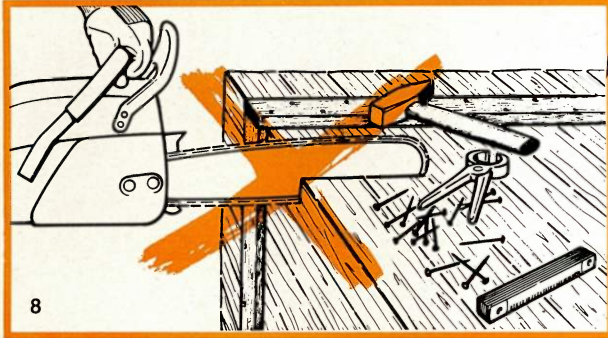

**Warning!**

Never touch a chain with your hand or any part of your body when the engine is running, even when the chain is not rotating. The chain continues to rotate for a short period after the throttle trigger is released.

**Warning!**

Do not cut any material other than wood or wooden objects.

10

Use your chain saw for cutting only. It is not designed for prying or shoveling away limbs, roots or other objects.

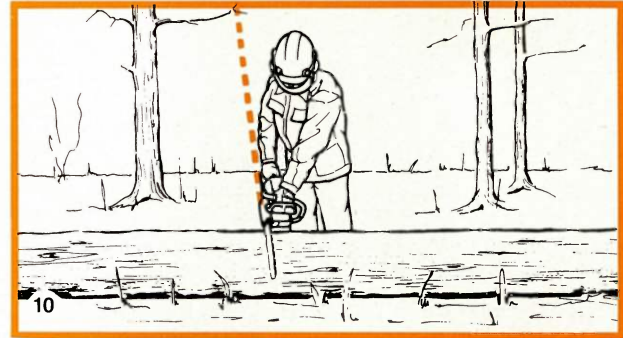

When sawing, make sure that the saw chain does not touch any foreign materials such as rocks, fences, nails and the like (ill.8). Such objects may be flung off, damage the saw chain or cause the saw to kick back.

In order to keep control of your saw, always maintain a firm foothold, Never work on a ladder, in a tree or on any other insecure support. Never use the saw above shoulder height (ill. 9).

Position the chain saw in such a way that your body is clear of the cutting attachment whenever the engine is running. Stand to the left of cut while bucking (see ill. 10).

Don't put pressure on the saw when reaching the end of a cut. The pressure may cause the bar and rotating chain to pop out of the cut or kerf, go out of control and strike the operator or some other object. If the rotating chain strikes some other object, a reactive force (see pages 10 to 16) may cause the moving chain to strike the operator.

**Reactive forces including kickback**

**Warning!**

Reactive forces may occur any time the chain is rotating.

Reactive forces can be dangerous! In any chain saw, the powerful force used to cut wood can be reversed (and work against the operator).

If the rotating chain is suddenly stopped by contact with any solid object like a log or branch or is pinched, the reactive forces may occur instantly. These reactive forces may result in loss of control which may, in turn, cause serious or fatal injury. An understanding of the causes of these reactive forces may help you avoid loss of control.

The most common reactive forces are

- kickback,
- pushback,
- pull-in.

#### **Kickback:**

Kickback occurs when the upper quadrant of the bar nose contacts a solid object or is pinched (ill. 11). The reaction of the cutting force of the chain causes a rotational force on the chain saw in the direction opposite to the chain movement. This may fling the bar up and back in an uncontrolled arc mainly in the plane of the bar. Under some cutting circumstances the bar moves towards the operator, who may suffer severe or fatal injury. Kickback may occur when the nose of the guide bar is pinched unexpectedly, unintentionally contacts solid material in the wood, (ill. 12) or is incorrectly used to begin a plunge or boring cut. It may also occur during limbing.

The greater the force of the kickback reaction, the more difficult it becomes for the operator to control the saw.

Many factors influence the occurrence and force of the kickback reaction. These include chain speed, the speed at which the bar and chain contact the object, the angle of contact, the condition of the chain and other factors.

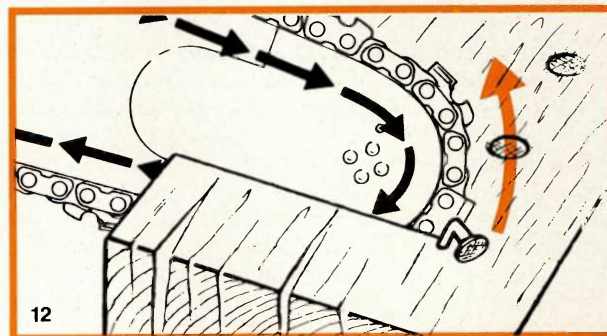
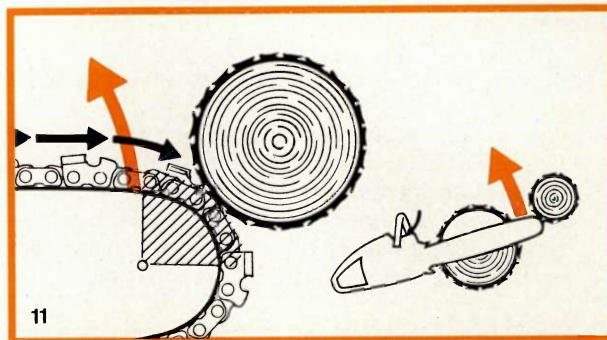

The type of bar and saw chain you use is an important factor in the occurrence and force of the kickback reaction. Some STIHL bar and chain types are designed to reduce kickback forces. STIHL recommends the use of reduced kickback bars and low kickback chains.

#### **ANSI B 175.1-1985 chain saw kickback standard**

Section 4.12 of ANSI standard B 175.1-1985, sets certain performance and design criteria related to chain saw kickback.

To comply with section 4.12 of ANSI B 175.1–1985:

a) saws with a displacement of less than 3.8 cubic inches

- must, in their original condition, meet a 45° computer derived kickback angle when equipped with certain cutting attachments described on page 12,
- and must be equipped with at least two devices to reduce the risk of kickback injury, such as a chain brake, low kickback chain, reduced kickback bar, etc.

b) saws with a displacement of 3.8 cubic inches and above

- must be equipped with at least one device designed to reduce the risk of kickback injury such as a chain brake, low kickback chain, reduced kickback bar, etc.

These kickback requirements do not apply to chain saws fitted with bow guides. Bow-equipped saws are only for use by thoroughly instructed and experienced operators. Use of bow guides may result in serious or fatal injury. See section entitled “Bow Guides” of this Manual.

The computer derived angles for saws below 3.8 cubic inch displacement are measured by applying a computer program to test results from a kickback test machine.

**Warning!**

The computer derived angles of § 4.12 of ANSI B 175.1–1985 may bear no relationship to actual kickback bar rotation angles that may occur in real life cutting situations. Compliance with § 4.12 of ANSI B 175.1–1985 does not automatically mean that in a real life kickback the bar and chain will rotate at most 45°.

**Warning!**

In order for powerheads below 3.8 cubic inch displacement to comply with the computed kickback angle requirements of § 4.12 of ANSI B 175.1–1985 use only the following cutting attachments:

- bar and chain combinations listed as complying in the “Specifications” section of the Owner’s Manual or
- other replacement bar and chain combinations marked in accordance with the standard for use on the powerhead or
- replacement chain designated “low kickback saw chain”<sup>1)</sup>.

**Warning!** There are potential powerhead and bar combinations with which low kickback saw chains can be used which have not been specifically certified to comply with the 45° computer derived kickback angle of § 4.12 of ANSI B 175.1–1985. Some low kickback chains have not been tested with all powerhead and bar combinations. STIHL offers a variety of bars and chains. STIHL reduced kickback bars and low kickback chains are designed to reduce the risk of kickback injury. Other chains are designed to obtain higher cutting efficiency or sharpening ease but may result in higher kickback tendency.

STIHL has developed a color code system to help you identify the STIHL reduced kickback bars and low kickback chains. Cutting attachments with green warning decals or green labels on the packaging are designed to reduce the risk of kickback injury. The matching of green decal powerheads under 3.8 cubic inch displacement with green labeled bars and green labeled chains gives compliance with the computed kickback angle requirements of ANSI B 175.1–1985 when the products are in their original condition. Products with yellow decals or labels are for users with extraordinary cutting needs and experience

<sup>1)</sup> “Low kickback saw chain” is a chain which has met the kickback performance requirements of § 4.12.2.4 of ANSI B 175.1–1985 (Safety Requirements for Gasoline-Powered Chain Saws) when tested on a selected representative sample of chain saws below 3.8 cubic inch displacement specified in ANSI B 175.1–1985.

and specialized training for dealing with kickback.

**STIHL recommends the use of its green labeled reduced kickback bars, green labeled low kickback chains and a STIHL Quickstop chain brake for both experienced and inexperienced chain saw users.**

Please ask your STIHL dealer to properly match your powerhead with the appropriate bar/chain combinations to reduce the risk of kickback injury. Green labeled bars and chains are recommended for all powerheads. See your "STIHL Bar and Chain Information" leaflet for details.

**Warning!** Use of other, non-listed bar/chain combinations may increase kickback forces and increase the risk of kickback injury.

New bar/chain combinations may be developed after publication of this literature, which will, in combination with certain powerheads, comply with § 4.12 of ANSI B 175.1-1985. Check with your STIHL dealer for such combinations.

### **Bow Guides**

**Warning!** Any chain saw equipped with a bow guide is potentially very dangerous. Improper use can result in kickback, pushback or pull-in, and very serious injury or death. Only thoroughly instructed and experienced operators should use a chain saw equipped with a bow guide.

A bow guide (or bow bar) is a specially designed substitution for a regular guide bar. Like a regular guide bar, it supports and guides the saw chain. Unlike a regular guide bar, it consists of a narrow rail structure with a large open space in the middle.

**Warning!** The risk of kickback is increased with a bow guide because of the increased kickback contact area. STIHL recommends the use of the STIHL Quickstop chain brake. Low kickback chain **will not** significantly reduce the risk of kickback injury when used on a bow guide.

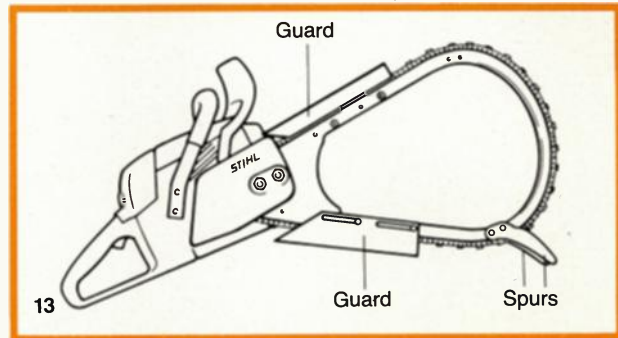

Only STIHL bow guides are approved for use with STIHL powerheads. The use of other bow guides with a STIHL powerhead can be hazardous to the operator due to the absence of safety guards and spurs and necessary unauthorized modifications needed to mount the bow guide to the STIHL powerhead.

Do not use a STIHL bow guide on any powerhead except a STIHL powerhead. Unauthorized combinations are dangerous.

### **Warning!**

Never attempt to operate a chain saw equipped with a bow guide unless the spurs and both guards are in place (ill. 13). Under no circumstances should any of the spurs or guards be removed. Keep the nuts which hold these items in place tightened at all times.

The guards at the top and bottom of the bow guide are required to reduce the possibility of injury caused by contact with the chain. These guards are slotted to allow positioning as close to the powerhead as possible. After the bow guide is mounted on the chain saw, slide the guards as close to the powerhead as possible.



The spurs should always be placed firmly against the wood before starting a cut (ill. 14) and should be kept against the wood until the cut is completed. Failure to keep the spurs firmly against the wood during the entire cut could cause the saw to react violently and could result in serious injury or death to the operator.

**Warning!**

Be sure to keep the chain properly tensioned. A chain which "sags" or is too loose could jump off the bow and result in serious injury to the operator. Felling with a bow bar is dangerous, because it is more difficult to follow safe felling techniques.

Cut only one log at a time.

A chain catcher which has been removed to allow mounting of a bow guide must be reattached when remounting the regular guide bar.

**Devices for reducing the risk of kickback injury**

STIHL recommends the use of the STIHL Quickstop chain brake on your powerhead with green labeled reduced kickback bars and low kickback chains.

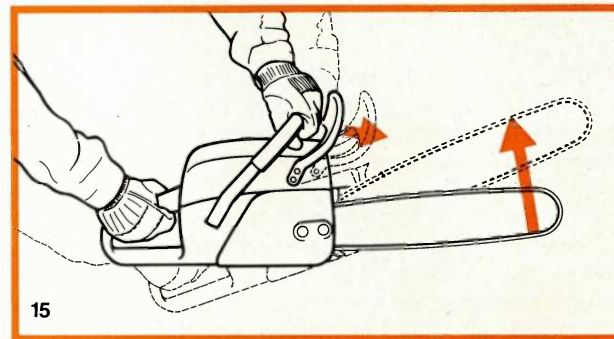

**Quickstop chain brake**

STIHL has developed a chain stopping system designed to reduce the risk of injury in certain kickback situations. It is called a Quickstop chain brake. The Quickstop is available as standard equipment on your STIHL chain saw and is available for installation on most older STIHL saws. Ask your dealer to retrofit your older model saw with a chain brake.

When a kickback occurs, the guide bar may rotate around the front handle. If the cutting position is such that the operator's left hand is gripping the front handle behind the hand guard, and if the left hand rotates around the front handle and contacts the front hand guard, which is the Quickstop activating lever, this contact will activate the Quickstop (see ill. 15). The chain brake on most new model STIHL chain saws can also be activated by inertia. See the chapter entitled "Chain Brake" of your Owner's Manual.

**Warning!**

Never operate your chain saw without a front hand guard. In a kickback situation this guard helps protect your left hand or other parts of your body. In addition, removal of the hand guard on a saw equipped with a chain brake will deactivate the chain brake.



**Warning!**

No Quickstop or other chain brake device prevents kickback. These devices are designed to reduce the risk of kickback injury, if activated, in certain kickback situations. In order for the Quickstop to reduce the risk of kickback injury, it must be properly maintained and in good working order. See the chapter entitled "Chain Brake" and "Maintenance, Repair and Storing" of your Owner's Manual. In addition, there must be enough distance between the bar and the operator to ensure that the Quickstop has sufficient time to activate and stop the chain before potential contact with the operator.

**Warning!**

An improperly maintained chain brake may increase the time needed to stop the chain after activation, or may not activate at all.

**Reduced kickback bar**

STIHL green labeled reduced kickback bars are designed to reduce the risk of kickback injury when used with STIHL green labeled low kickback chains.

**Warning!**

When used with other, more aggressive chains, these bars may be less effective in reducing kickback, and may result in higher kickback forces.

**Low kickback chain**

Some types of saw chain have specially designed components to reduce the force of nose contact kickback. STIHL has developed low kickback chain for your powerhead.

**Warning!**

A dull or improperly sharpened chain may reduce or negate the effects of the design features intended to reduce kickback energy. Improper lowering or sharpening of the depth gauges or shaping of the cutters may increase the chance and the potential energy of a kickback. Always cut with a properly sharpened chain.

**Warning!**

Reduced kickback bars and low kickback chains do not prevent kickback, but they are designed to reduce the risk of kickback injury. They are available from your STIHL dealer.

**Warning!**

Even if your saw is equipped with a Quickstop, a reduced kickback bar and/or low kickback chain, this does not eliminate the risk of injury by kickback. Therefore always observe all safety precautions to avoid kickback situations.

**To avoid kickback**

The best protection from personal injury that may result from kickback is to avoid kickback situations:

1. Hold the chain saw firmly with both hands and maintain a secure grip.
2. Be aware of the location of the guide bar nose at all times.
3. Never let the nose of the guide bar contact any object. Do not cut limbs with the nose of the guide bar. Be especially careful when cutting small, tough limbs, small size brush and saplings which may easily catch the chain.
4. Don't overreach.
5. Don't cut above shoulder height.
6. Begin cutting and continue at full throttle.
7. Cut only one log at a time.
8. Use extreme caution when re-entering a previous cut.
9. Do not attempt to plunge cut (see page 20) if you are not experienced with these cutting techniques.
10. Be alert for shifting of the log or other forces that may cause the cut to close and pinch the chain.
11. Maintain saw chain properly. Cut with a correctly sharpened, properly tensioned chain at all times.
12. Stand to the side of the cutting path of the chain saw.

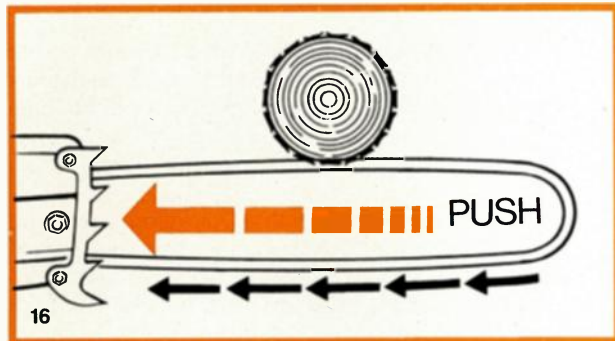

#### Pushback:

Pushback occurs when the chain on the top of the bar is suddenly stopped when it is pinched, caught or encounters a foreign object in the wood. The reaction of the chain drives the saw straight back toward the operator and may cause loss of saw control. Pushback frequently occurs when the top of the bar is used for cutting (see ill. 16).

#### To avoid pushback

1. Be alert to forces or situations that may cause material to pinch the top of the chain.
2. Do not cut more than one log at a time.
3. Do not twist the saw when withdrawing the bar from a plunge cut or underbuck cut (figures 26 to 30 and 34, pages 19, 20 and 22), because the chain can pinch.

16

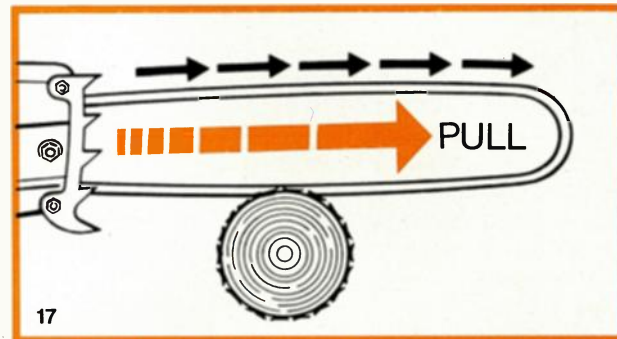

#### Pull-in:

Pull-in occurs when the chain on the bottom of the bar is suddenly stopped. The chain on the bottom of the bar stops when it is pinched, caught or encounters a foreign object in the wood (see ill. 17). The reaction of the chain pulls the saw forward and may cause the operator to lose control.

Pull-in frequently occurs when the bumper spike of the saw is not held securely against the tree or limb and when the chain is not rotating at full speed before it contacts the wood.

#### Warning!

Use extreme caution when cutting small size brush and saplings which may easily catch the chain and pull you off balance.

#### To avoid pull-in

1. Always start a cut with the chain rotating at full speed and the bumper spike in contact with the wood.
2. Pull-in may also be prevented by using wedges to open the kerf or cut.

## Cutting Techniques

### Felling

Felling is cutting down a tree.

Before felling a tree, consider carefully all conditions which may affect the direction of fall, including:

The intended direction of the fall.

The natural lean of the tree.

Any unusually heavy limb structure.

Surrounding trees and obstacles.

The wind direction and speed.

### Warning!

Always observe the general conditions of the tree. Look for decay and rot in the trunk. If it is rotted inside, it could snap and fall toward the operator while being cut.

Also look for broken or dead branches which could vibrate loose and fall on the operator. When felling on a slope, the operator should stand on the uphill side if possible.

When felling in the vicinity of roads, railways and power lines, etc., take extra precautions. Inform the police, utility company or railway authority before beginning to cut.

When felling, maintain a distance of at least 2½ tree lengths from the nearest person (see ill. 18).

### Note:

The noise of your engine may drown any warning call.

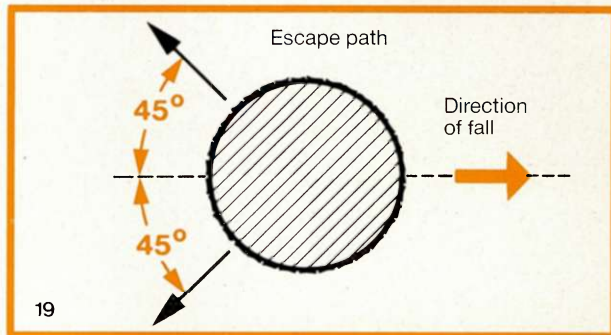
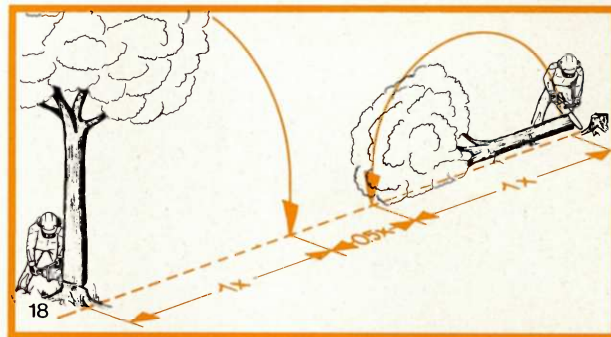

### Felling Instructions:

First clear the tree base and work area from interfering limbs and brush and clean its lower portion with an axe.

Then, establish a path of escape and remove all obstacles. This path should be generally opposite to the planned direction of the fall of the tree and about at a 45° angle (ill. 19). An alternate path must also be selected. Place all tools and equipment a safe distance away from the tree, but not on the escape path.

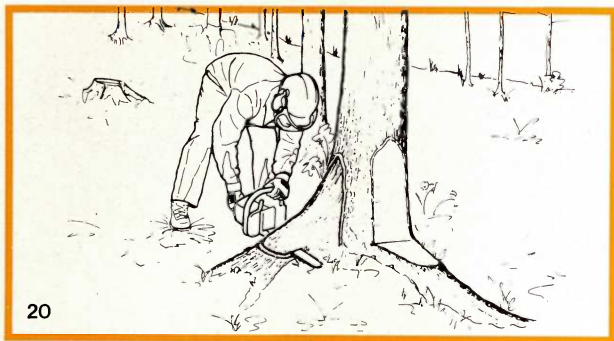

20

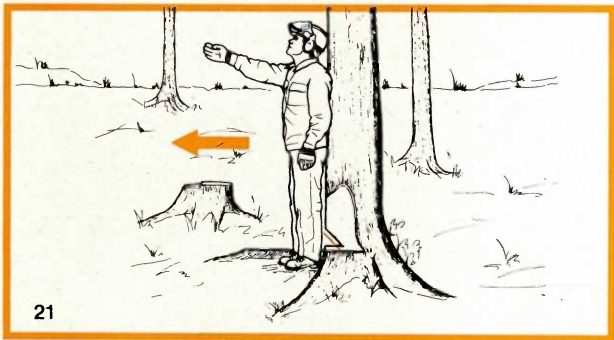

21

If the tree has large buttress roots, cut into the largest buttress vertically first (horizontally next) and remove the resulting piece (ill. 20).

Two felling techniques are recommended, the conventional cut and the open-face cut. With either technique the first step is to determine the placement of the felling notch on the side of the tree in the planned direction of the fall (ill. 21). When properly placed the felling notch determines the direction in which the tree will fall. It is made perpendicular to the line of fall and should be close to the ground.

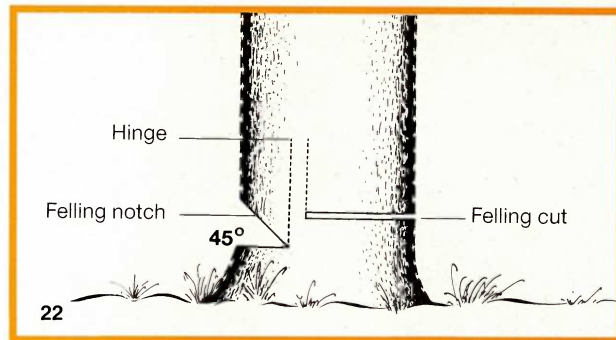

22

With the **conventional cut** begin with the top cut of the felling notch, and cut down at approximately a 45-degree angle to a depth of about  $\frac{1}{5}$  to  $\frac{1}{4}$  of the trunk diameter. Make the second or lower cut horizontal until it meets the first cut. Remove the resulting 45-degree piece (ill. 22).

With the **open-face technique**, the object is to make a 90-degree notch in the tree trunk to a depth of approximately  $\frac{1}{5}$  to  $\frac{1}{4}$  of the tree's diameter. Beginning with the top cut of the notch, cut down at approximately a 50-degree angle to a depth of approximately  $\frac{1}{5}$  to  $\frac{1}{4}$  of the diameter of the tree. Make a second cut from below also at approximately a 40-degree angle. Remove the resulting 90-degree open-face piece (ill. 23).

With both techniques, the felling notch should be made very carefully. When making the second cuts, look through the previously made kerf to insure that the two cuts meet properly.

Once the felling notch has been completed, you are ready to begin the felling cut on the opposite side of the tree. With the **conventional and open face notch**, begin the

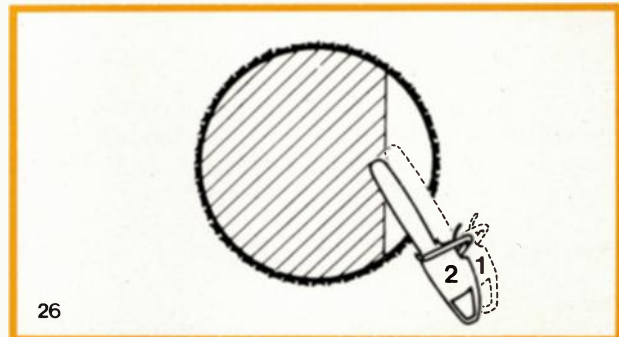
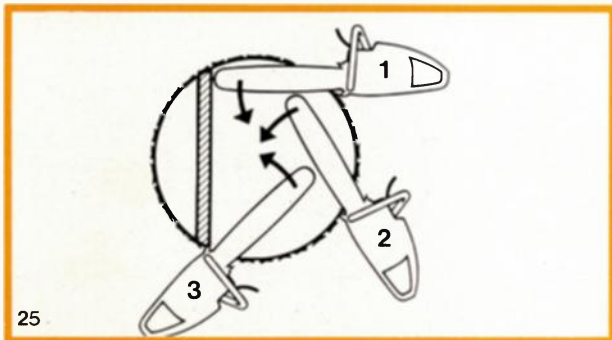
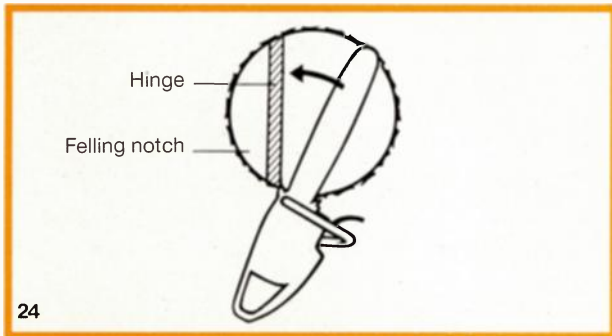
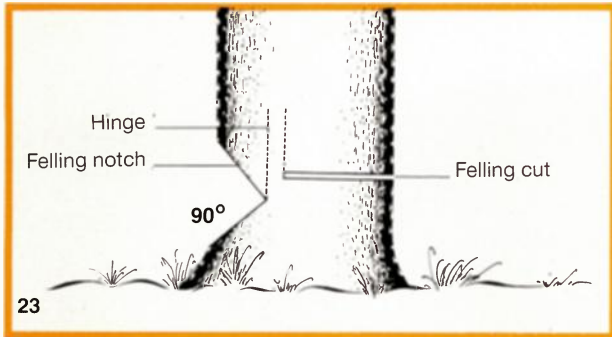

felling cut 1 to 2 inches higher than the center of the felling notch (ill. 22). Cut horizontally through the tree towards the felling notch. Engage the bumper spikes of the chain saw directly behind the uncut portion of wood and cut towards the notch (ill. 24). Leave approximately  $\frac{1}{10}$  of the tree diameter uncut. This is the hinge. Do not cut through the hinge because you could lose control of the direction of the fall. Drive wedges into the felling cut where necessary to control the fall.

#### Warning!

If the tip of the bar contacts a wedge, it may cause kick-back.

Wedges should be of wood or plastic – never steel which can damage the chain.

Always keep to the side of the falling tree. When the tree starts to fall, withdraw the bar, shut off the engine and walk away on the preplanned escape path. Watch out for falling limbs.

### Warning!

Be extremely careful with partially fallen trees which are poorly supported.

When the tree hangs or for some other reason does not fall completely, set the saw aside and pull the tree down with a cable winch, block and tackle or tractor. If you try to cut it down with your saw, you may be injured.

### Sectioning Method

#### Warning!

Felling a tree that has a diameter greater than the length of the guide bar requires use of either the sectioning or plunge-cut method. These methods are extremely dangerous because they involve the use of the nose of the guide bar and can result in kickback. Only properly trained professionals should attempt these techniques.

For the sectioning method (ill. 25) make the first part of the felling cut with the guide bar fanning in toward the hinge. Then, using the bumper spike as a pivot, reposition the saw for the next cut. Avoid repositioning the saw more than necessary. When repositioning for the next cut, keep the guide bar fully engaged in the kerf to keep the felling cut straight. If the saw begins to pinch, insert a wedge to open the cut. On the last cut, do not cut the hinge.

### Plunge-Cut Method

Timber having a diameter more than twice the length of the guide bar requires the use of the plunge-cut method before making the felling cut.

First, cut a large, wide felling notch. Make a plunge cut in the center of the notch.

The plunge cut is made with the guide bar nose. Begin the plunge cut by applying the lower portion of the guide bar nose to the tree at an angle (ill. 26). Cut until the depth of the kerf is about the same as the width of the guide bar

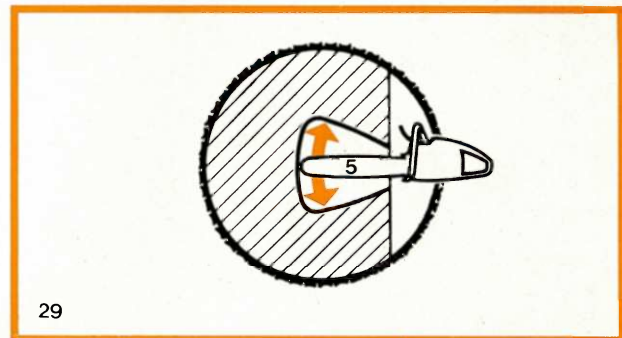
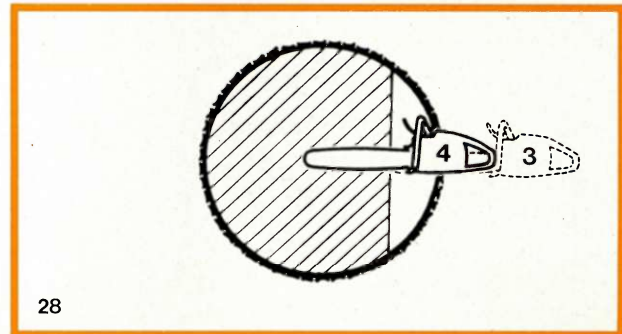
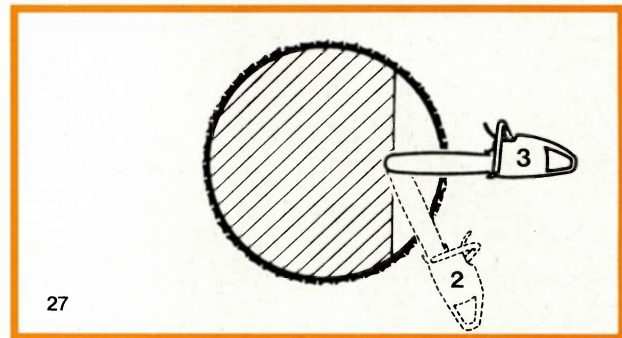

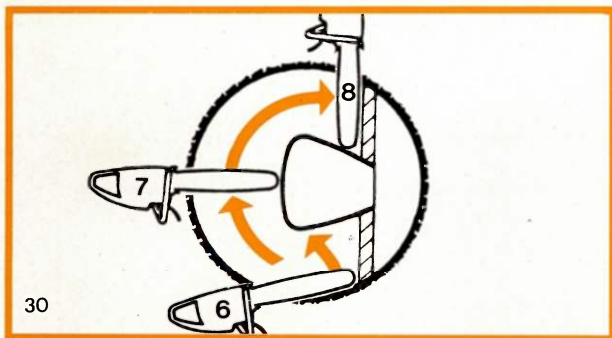

(ill. 27). Next, align the saw in the direction in which the recess is to be cut.

With the saw at full throttle, insert the guide bar in the trunk (ill. 28).

Enlarge the plunge cut as shown in illustration (ill. 29).

### **Warning!**

There is an extreme danger of kickback at this point. Extra caution must be taken to maintain control of the saw. To make the felling cut, follow the sectioning method described previously (ill. 30).

If you are inexperienced with a chain saw, plunge-cutting should not be attempted. Seek the help of a professional.

### **Limbing**

Limbing is removing the branches from a fallen tree.

### **Warning!**

There is an extreme danger of kickback during the limbing operation. Do not work with the nose of the bar. Be extremely cautious and avoid contacting the log or other limbs with the nose of the guide bar.



Do not stand on a log while limbing it – you may slip or the log may roll.

Start limbing by leaving the lower limbs to support the log off the ground (ill. 31). When underbucking freely hanging limbs, a pinch may result or the limb may fall, causing loss of control.

If a pinch occurs, stop the engine and remove the saw, by lifting the limb.

### **Warning!**

Be extremely cautious when cutting limbs or logs under tension (spring poles). The limbs or logs could spring back toward the operator and cause loss of control of the saw and severe or fatal injury to the operator.

### **Bucking**

Bucking is cutting a log into sections.

### **Warnings!**

1. When bucking, do not stand on the log. Make sure the log will not roll downhill. If on a slope, stand on the uphill side of the log (see ill.32). Watch out for rolling logs.



32

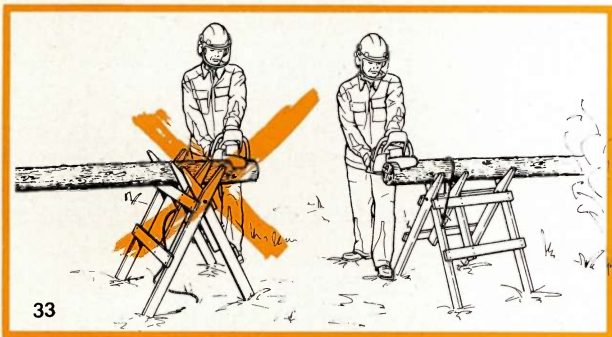

33

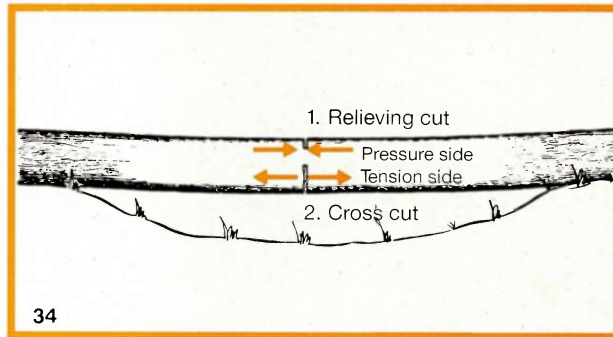

34

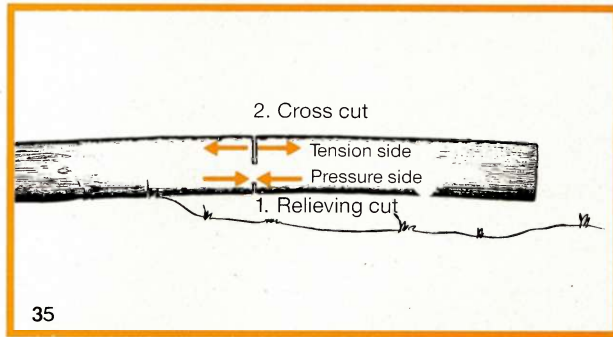

35

2. Cut only one log at a time.
3. Shattered wood should be cut very carefully. Sharp splinters of wood may be caught and flung in the direction of the operator of the saw.
4. When cutting small logs, use a sawhorse (ill. 33). Never permit another person to hold the log. Never hold the log with your leg or foot.
5. Logs under strain require special attention to prevent

the saw from pinching. The first cut is made on the compression side to relieve the stress on the log (see ill. 34, 35). The bucking cut is then made as shown. If the saw pinches, stop the engine and remove it from the log.

6. Only properly trained professionals should work in an area where the logs, limbs and roots are tangled. Working in blowdown areas is extremely hazardous.
7. Drag the logs into a clear area before cutting. Pull out exposed and cleared logs first.



## MAINTENANCE, REPAIR AND STORING

Use only STIHL replacement parts for maintenance and repair. Use of parts manufactured by others may cause serious or fatal injury.

Never operate a chain saw that is damaged, improperly adjusted or not completely or securely assembled. Follow the maintenance and repair instructions in the appropriate section of your owner's manual, especially those in the chapters "Guide Bar, Chain and Sprocket", "Sharpening and Maintenance of Saw Chain" and "Chain Brake".

**Warning!** Always stop the engine and ensure that the chain is stopped before making any adjustments, maintenance or repair work, changing the saw chain or cleaning the saw. Do not attempt any maintenance or repair work not described in your owner's manual. Have such work performed at your STIHL service shop only. Check fuel filler cap for leaks at regular intervals. Use the specified spark plug and make sure it and the ignition lead are always in good condition.

Keep spark plug and wire connection tight and clean. The spark plug electrode gap should be checked with a feeler gauge at least every 50 operating hours and reset if necessary. Fit a new spark plug if the electrodes are badly pitted.

**Warning!** STIHL provides a spark arresting muffler on each chain saw designed to reduce the risk of fire and hearing loss. Never operate a saw when the spark-arresting screen is missing from the muffler, or when the muffler is worn, damaged, missing or modified. Remember that the risk of forest fires is greater in hot weather. Never touch a hot muffler or burn will result.

Keep the chain, bar and sprocket clean; replace worn sprockets or chains.

Keep the chain sharp. You can spot a dull chain when

easy-to-cut wood becomes hard to cut and burn marks appear on the wood.

Keep the chain at proper tension. Tighten all nuts, bolts and screws except the carburetor adjustment screws after each use.

**Warning!** In order for the chain brake on your STIHL chain saw to properly perform its function of reducing the risk of kickback and other injuries, it must be properly maintained. Like an automobile brake, a chain saw chain brake incurs wear each time it is engaged.

The amount of wear will vary depending upon usage, conditions under which the saw is used and other factors. Excessive wear will reduce the effectiveness of the chain brake and can render it inoperable. For the proper and effective operation of the chain brake the brake band and clutch drum must be kept free of dirt, grease and other foreign matter which may reduce friction of the band on the drum.

For these reasons, each STIHL chain saw should be returned to trained personnel such as your Stihl servicing dealer for periodic inspection and servicing of the brake system according to the following schedule:

Heavy usage – every three months,

Moderate usage – twice a year,

Occasional usage – annually.

The brake band should be replaced whenever wear has reduced any portion of its original thickness by 25% or more. Additionally, the daily maintenance schedule for your chain saw set forth in your STIHL owner's manual should be strictly followed.

Store chain saw in a dry place and away from children. Before storing for longer than a few days always empty the fuel tank.

## Fuel

Fuel filler cap removed

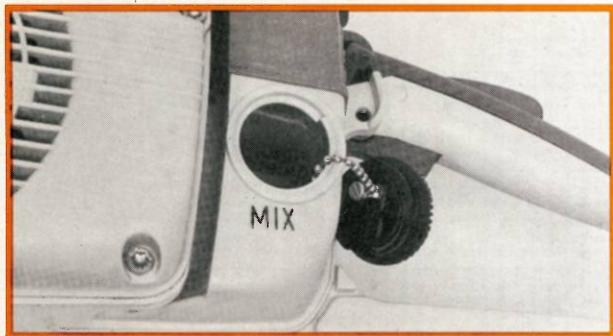

Your two-stroke engine runs on a mixture of gasoline and two-stroke, air-cooled engine oil.

Use regular branded unleaded gasoline with a minimum octane number of 90 ROZ (U.S.A./Canada: pump octane min. 87!). If the octane number of the regular grade gasoline in your area is lower use premium unleaded fuel. Fuel with a lower octane number may result in preignition (causing "pinging") which is accompanied by an increase in engine temperature. This, in turn, increases the risk of the piston seizure and damage to the engine.

The chemical composition of the fuel is also important. Some fuel constituents not only detrimentally affect elastomers (carburetor diaphragms, oil seals, fuel lines etc.), but magnesium castings as well. This could cause running problems or even damage the fuel tank. For this reason it is essential that you use only name branded fuels!

Use only STIHL two-stroke engine oil or equivalent branded two-stroke air-cooled engine oils for mixing. We recommend STIHL 50:1/40:1 two-stroke engine oil since it is specially formulated for use in STIHL engines. The mix ratio with STIHL oil is 50:1/40:1 (50/40 parts gasoline to 1 part oil), or 25:1 (25 parts gasoline to 1 part oil) with other branded two-stroke air-cooled engine oils.

Do not use BIA or TCW (two-stroke water cooled) mix oils!

| Gasoline | STIHL-oil<br>50:1 |            | STIHL-oil<br>40:1 |            | Other branded<br>two-stroke<br>eng. oils (25:1) |            |
|----------|-------------------|------------|-------------------|------------|---|------------|
|          | U.S.<br>gal       | U.S.<br>oz | U.S.<br>Lit.      | U.S.<br>oz | U.S.<br>Lit.                                    | U.S.<br>oz |
| 1.0      | —                 | 0.020      | —                 | 0.025      | —   | 0.04       |
| —        | 1                 | —          | 2½                | —          | ¾   | —          |
| 5.0      | —                 | 0.100      | —                 | 0.125      | —   | 0.20       |
| —        | 2½                | —          | 6½                | —          | 8   | —          |
| 10       | —                 | 0.200      | —                 | 0.250      | —   | 0.40       |
| —        | 5                 | —          | 12¾               | —          | 16  | —          |

Take care when handling gasoline. Avoid direct contact with the skin and avoid inhaling fuel vapour.

When mixing, pour oil into the canister first, and then add gasoline. The canister should be kept tightly closed in order to avoid any moisture getting into the mixture. The fuel mixture must not be stored for long periods of time. Do not store large quantities. Always mix sufficient fuel for about a few month's work or the project in hand.

Always thoroughly shake the mixture in the canister before fueling your machine. The fuel tank may be under pressure. Remove cap slowly!

The fuel tank and the canister in which fuel mix is stored should be cleaned from time to time. Before storing your machine for a long period, drain and clean the fuel tank and run engine until carburetor is dry.

Change the fuel pick up body every year.

## Chain Oil

Oil filler cap removed

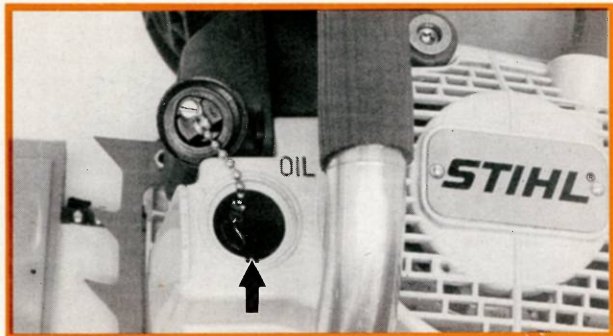

The saw chain and guide bar must be continuously lubricated during operation to protect them from abnormal wear. This is assured by the automatic chain oiling system. The speed-controlled oil pump always draws the amount of oil required out of the tank and feeds it to the guide bar groove. The oil pump feed rate is designed to provide adequate lubrication of the bar and chain under normal operating conditions using a standard length **E**matic guide bar. If you would like to increase the oil feed rate, contact your STIHL Dealer for assistance.

The capacities of the oil and fuel tanks are balanced in such a way that a certain amount of oil, depending on pump feed rate, is always left in the oil tank when the fuel tank is empty. This avoids the risk of the saw being used unintentionally without chain lubrication.

Always fill the oil tank with chain oil when you refuel. **Important:** If you find the oil tank is still full although the fuel tank is completely empty, the reason may be a fault in the chain oil supply system. In such a case, check chain lubrication and, if necessary, clean the oilways or contact your STIHL Dealer for assistance.

1 = Oilway in crankcase  
2 = Oil inlet hole in guide bar

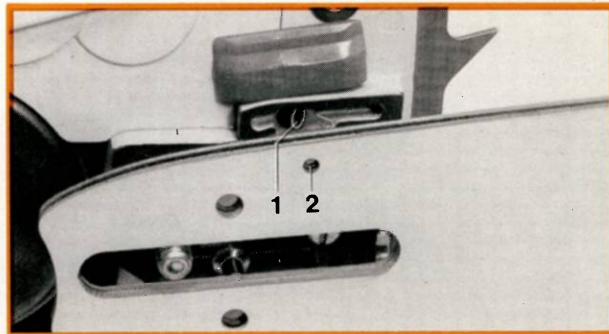

The service life of the saw chain and guide bar is greatly dependent on the quality of the lubricant. Only use the chain oil approved and recommended by STIHL.

### Warning!

Medical studies have shown that renewed contact with waste oil can cause skin cancer. Avoid direct contact with waste oil. If waste oil does get on your skin, wash with soap and water. **Do not use** waste oil for any purpose, and dispose it only at authorized disposal locations.

If special chain lubricant is not available you may – in an emergency – use one of the high-duty, single grade engine oils listed below. Choose the oil according to the prevailing outside temperature.

| Outside temperature                | Grade                   |
|------------------------------------|-------------------------|
| +10 °C to +40 °C (50 °F to 104 °F) | SAE 30                  |
| +10 °C to –10 °C (50 °F to 14 °F)  | SAE 20                  |
| –10 °C to –30 °C (14 °F to 22 °F)  | SAE 20 W or<br>SAE 10 W |

Before refilling, carefully clean the filler cap and the area around it to ensure that no dirt falls into the tank.

## Mounting the Bar and Chain

Chain brake released

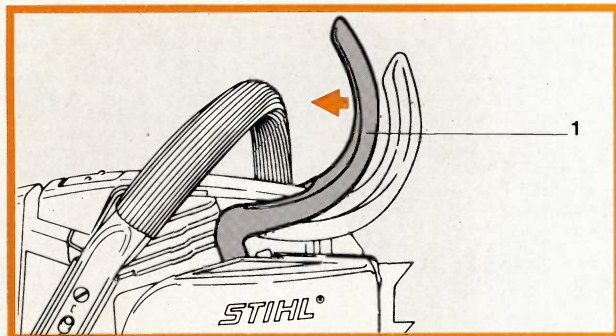

There are two types of chain tensioner. Depending on the model you have, tensioning is performed either through the side of the sprocket cover or from the front of the machine.

Release the chain brake by pulling the front hand guard (1) back toward the handlebar.

Unscrew the hexagon nuts (2) and take off the chain sprocket cover (3).

Use the screwdriver end of the combination wrench to turn the adjusting screw (4) (lateral chain tensioner) or the tensioning screw (5) (front chain tensioner) counterclockwise as far as the stop. This backs off the tensioner slide or tensioning nut (6).

The cutting edges of the chain are very sharp. You should always wear gloves to protect your hands from injury when fitting the chain, mounting the guide bar, tensioning the chain and checking chain tension.

Top: Removing chain sprocket cover  
Center: Backing off tensioner slide on lateral chain tensioner  
Bottom: Backing off tensioning nut on front chain tensioner

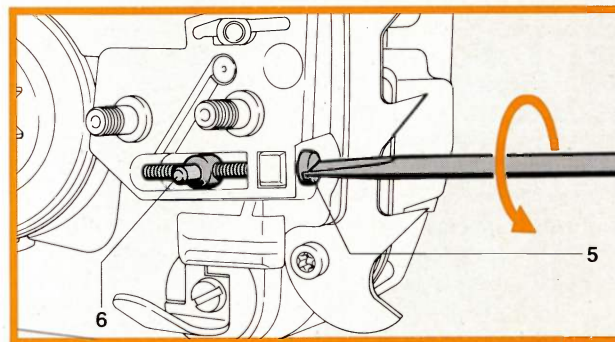
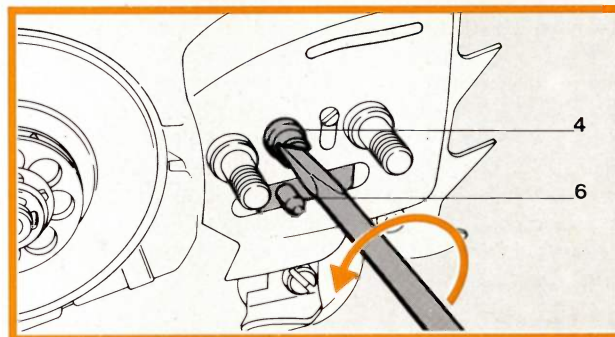
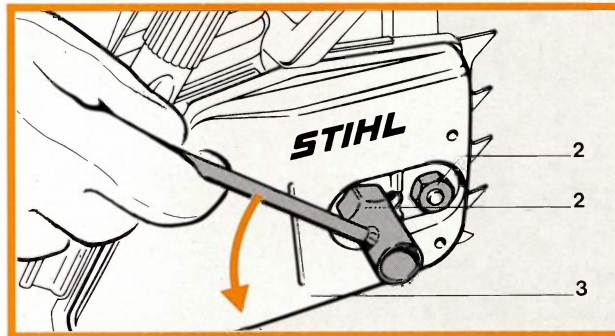

- Top: Fitting saw chain on guide bar
- Center: Fitting the chain on the sprocket – cutting edges point toward bar nose
- Bottom: Peg of tensioner slide/tensioning nut in locating hole – guide bar flat against saw body

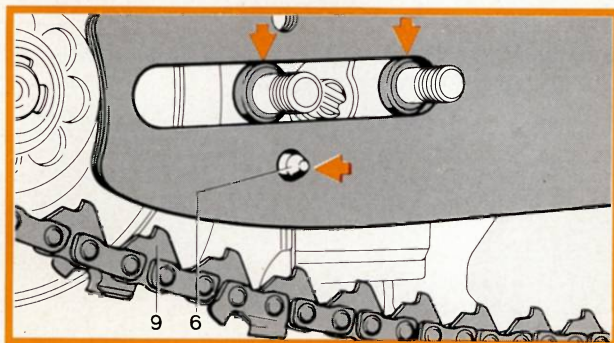
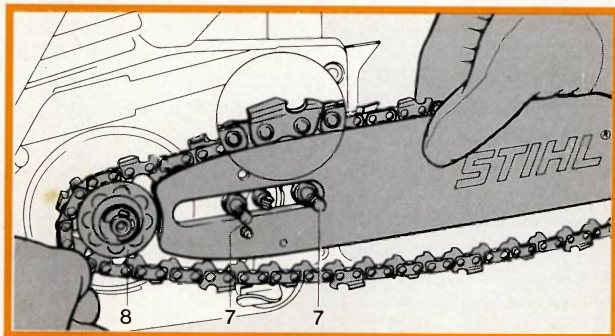
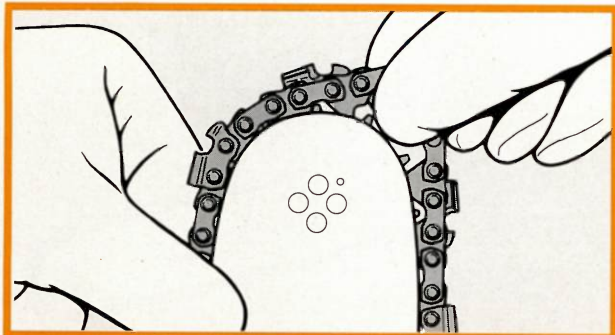

#### Pretensioning the chain (lateral chain tensioner)

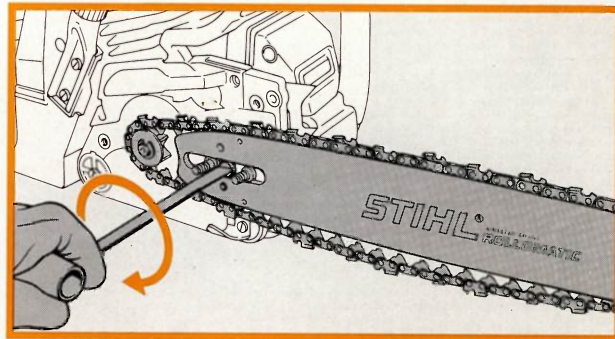

Hold the guide bar vertically with the nose upward and fit the Oilomatic chain on it, starting at the bar nose.

With the chain in position, locate the slot of the guide bar over the studs (7) and place the Oilomatic chain over the sprocket (8) at the same time. Be sure that the cutting edges on the top of the bar point toward the bar nose. The peg of the tensioner slide/tensioning nut (6) must engage the lower guide bar locating hole.

Now tension the chain by turning the adjusting screw (4) or tensioning screw (5) clockwise until there is very little chain sag on the underside of the bar. Make sure that the drive link tangs (9) are properly located in the guide bar groove.

Fit the sprocket cover (3) on the studs (7) and screw on the hexagon nuts (2) finger-tight.

## Tensioning the Saw Chain

Top: Tensioning the chain (lateral chain tensioner)  
Bottom: Holding bar nose up and tightening the hexagon nuts

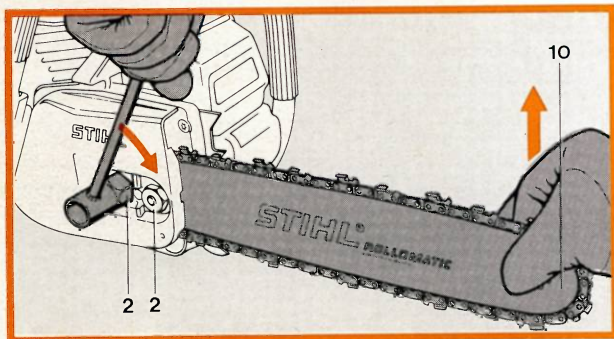
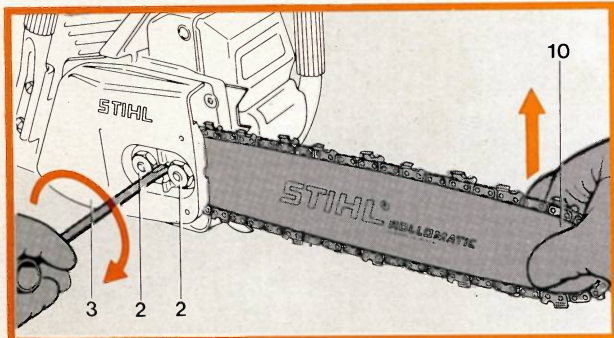

The chain must be tensioned after initial assembly and retensioned during cutting work.

To retension the chain, first slacken off the hexagon nuts (2). Insert screwdriver end of combination wrench through hole in chain sprocket cover.

Hold the bar nose (10) up and turn the adjusting screw (lateral chain tensioner) or tensioning screw (front chain tensioner) clockwise with the screwdriver until the chain lies against the underside of the bar. While still holding the bar nose up, **firmly** tighten down the hexagon nuts (2).

Checking chain tension

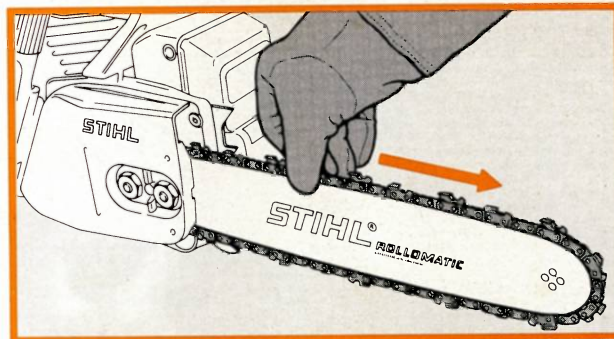

The Oilomatic chain is correctly tensioned when it fits snugly against the underside of the bar but can still be pulled easily along the bar by hand (with chain brake disengaged). Important: Wear protective gloves when performing this work.

Proper chain tension and lubrication are critically important for the cutting performance and service life of your whole cutting attachment. Always check chain lubrication before starting work.

Chain tension should be checked frequently during cutting work and corrected as necessary. For further details see Chapter "Bar, Chain and Sprocket".

## Chain Brake

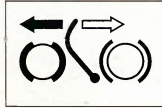

The chain brake can be activated either manually or by inertia.

- Manual engagement is effected by pushing the front hand guard forwards with the left hand.
- The mass moment of inertia of the front hand guard also engages the chain brake in certain situations.

If the kickback force of the saw is high enough, the mass moment of inertia of the hand guard provides the activating impulse for the chain brake.

### Warning!

The hand guard is an integral part of the chain braking system. It **must not** be modified in any way otherwise it will be deactivated.

The great advantage of the inertia chain brake is that the brake is activated after severe kickback even if the operator's left hand is not behind the front hand guard, e.g. as it the case when performing the felling cut.

### Engaging the chain brake

When the hand guard is moved towards the nose of the guide bar (either manually or by inertia), the brake lever is unlatched and the brake band is clamped round the clutch drum at the same instant. This causes the saw chain to be brought to a standstill and locked in position.

**Important:** Apart from starting and emergencies, the chain brake may be engaged only when the saw is idling.

### Releasing the chain brake

The locked saw chain must be released before cutting can be continued. To do this, pull the hand guard back toward the handlebar – this disengages the brake band from the clutch drum.

Top: Chain brake engaged  
Bottom: Chain brake released

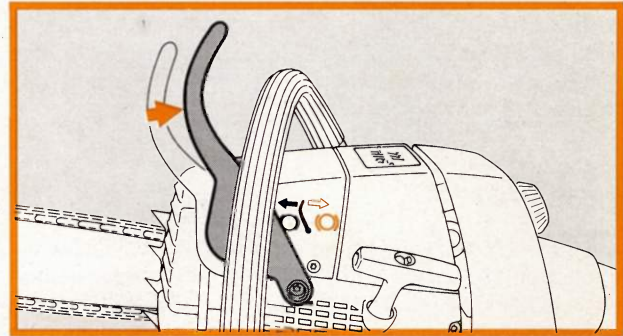
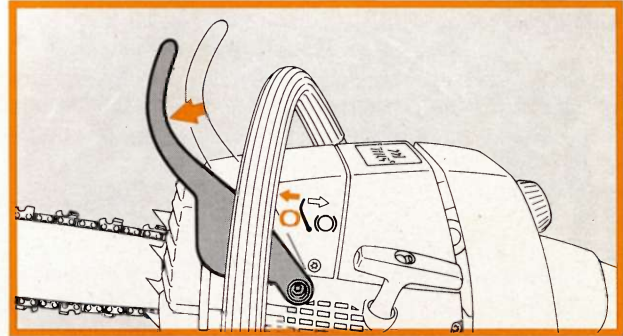

### Maintenance

The chain brake is subject to normal wear. Dust, oil or foreign debris in the chain brake mechanism may lead to increase chain stopping times. It is therefore necessary to have it regularly serviced and maintained! For specific chain brake maintenance instructions, see section "Maintenance, Repair and Storing" of the owner's manual.

Always carry out an operational check by activating it once before starting work. Make sure the hand guard is free from dirt to ensure that its smooth operation is not impaired in any way.

## General Notes on Operation

### Starting for first time

A factory new machine should be run with the carburetor set slightly on the rich side for the first three tank fillings (see chapter on "Carburetor") so that the cylinder bore and the bearings receive additional lubrication during the break-in period.

As all the moving parts have to bed in during the break-in period, the frictional resistances in the engine are greater during this period. For this reason the engine only develops its maximum power after about 5 to 15 tank fillings. The carburetor setting must never be made leaner in order to achieve an apparent increase in power as this could cause the engine to exceed its maximum permissible rpm (see "Specifications" and "Carburetor").

### During operation

After a long period of working at full load it is advisable not to shut off the engine immediately, but let run for a short while at idling speed. This allows the heat which has been generated in the engine during full throttle operation to be dissipated by the flow of cooling air and also protects engine-mounted components (ignition, carburetor) from thermal overload.

### Spark plug

An incorrect carburetor setting, the wrong fuel mix (too much engine oil in the gasoline), a dirty air filter and unfavorable running conditions (mostly at part throttle etc.) affect the condition of the spark plug. These factors cause deposits to form on the insulator nose which may result trouble in operation.

Top: Spark plug in good condition  
Bottom: Spark plug fouled because of incorrect running conditions

Autolite 2984



If the engine is down on power, difficult to start or runs poorly at idling speed, **check the spark plug before looking any further**. If the spark plug is dirty, clean it and check the electrode gap. Readjust if necessary; the correct gap is 0.5 mm (0.02 in). The spark plug should be replaced after about 100 operating hours or earlier if the electrodes are badly eroded.

In order to ensure trouble-free operation it is necessary to rectify the faults which have caused fouling of the spark plug.





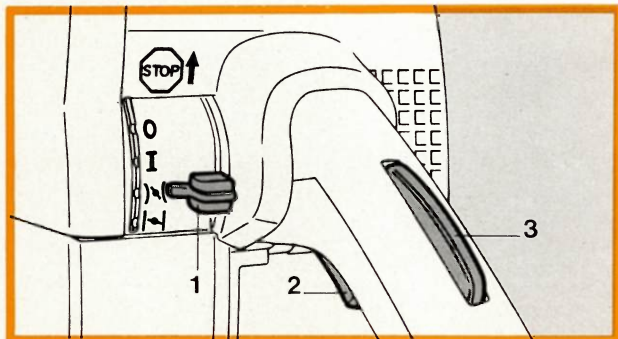

## Master Control

- 1 = Master Control lever
- 2 = Throttle trigger
- 3 = Throttle trigger interlock





The Master Control lever (1) controls the various engine functions. Depending on its position, it acts either on the carburetor's choke shutter, the throttle trigger (2) or the stop contact (for stopping the engine).





Note the following points when operating the Master Control lever:

1. When the Master Control lever is moved to  (this position can only be selected from **I**, the stop contact engages the contact spring – this cuts out the ignition system.
2. Press down throttle trigger interlock (3) before you move the Master Control lever (1) from "Run" **I** to  (or ). Do not squeeze the throttle trigger at the same time.
3. When the Master Control lever (1) is moved to "Warm START" , the choke shutter is opened and the throttle trigger (2) set to the starting-throttle position.

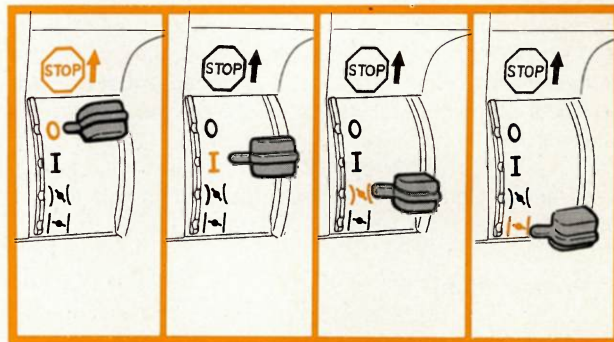
Positions of Master Control lever:

-  = Stop
- I** = Run
-  = Warm start
-  = Cold start



4. When in the "Warm Start" position , the Master Control lever (1) is locked by the throttle trigger (2) and must not be forced into the "Run" position **I**. It returns automatically to "Run" **I** when the throttle trigger (2) is squeezed.
5. When the Master Control lever (1) is moved to "Cold Start" , the choke shutter is closed and the throttle trigger (2) set to the starting-throttle position.
6. It is possible to move the Master Control lever (1) from  (to  or vice versa without touching any other controls.

## Starting

Before starting your saw, make sure you have a firm foothold and check that the saw chain is not touching the ground or any other obstacles. Bystanders must be kept well clear of the general work area of the saw.

See “Master Control” for full description of its functions.

### 1. Preparations

- 1.1 Engage the chain brake by pushing the hand guard (1) towards the bar nose.

**Note:** You will hear a definite click when the brake engages.

### 1.2 Adjust controls

**If the engine is cold:** Press down throttle trigger interlock (2) and move Master Control lever (3) to  (Cold Start).

**If engine is warm:** Press down throttle trigger interlock (2) and move Master Control lever (3) to  (Warm Start).

**Note:** Also select this position if engine has been running but is still cold.

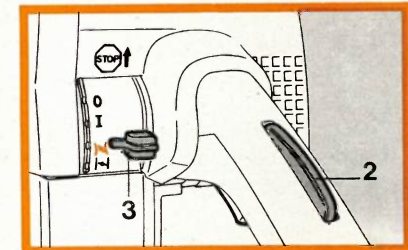
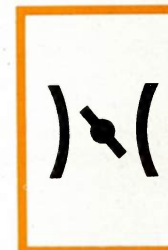
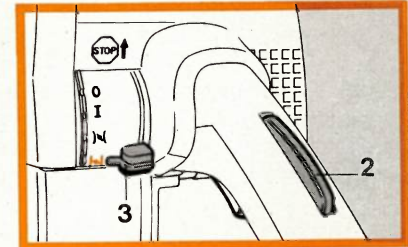
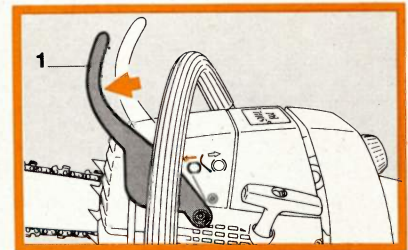
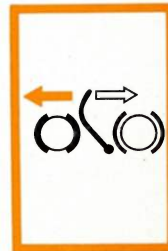

## 2. Starting procedure

2.1 You can hold the saw in one of two ways for starting:

### – Saw between legs

Hold the rear handle tightly between your legs, just above the knees. Grip the front handle (5) securely with your left hand.

### – Saw on ground

Hold the saw firmly on the ground with your left hand on the front handle (5). Put your right foot into the rear handle (6) and press down.

2.2 Pull the starter grip (7) slowly with your right hand until you feel the starter engage, then give the grip a brisk strong pull (the engine will kick back if you pull too slowly).

The starter rope must not be pulled out more than 70 cm (about 28 in) as it might otherwise break.

Do not let the starter grip (7) snap back. Guide it slowly into the housing so that the starter rope can rewinding properly.



2.3 **Important:** If starting in “Cold Start” position, move Master Control lever (1) to “Warm Start” position (as soon as engine begins to fire and then continue cranking until engine runs.

### 3. Engine running

3.1 Immediately blip the throttle trigger (8) so that Master Control lever moves to “Run” position and engine settles down to idle speed.

**Warning!** The clutch can be damaged if the engine is not immediately returned to idle speed.

3.2 Disengage the chain brake before starting work, i.e. pull the hand guard (1) back towards the front handle.

### 4. Stopping engine

The engine is stopped by moving the Master Control lever (3) to .

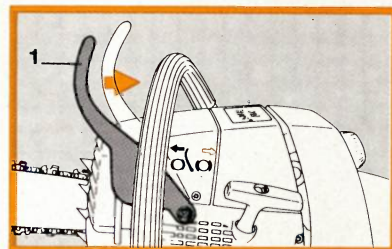
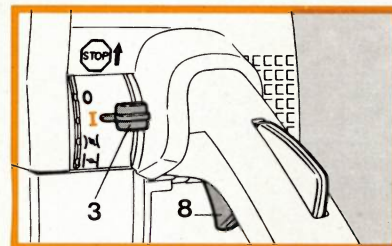
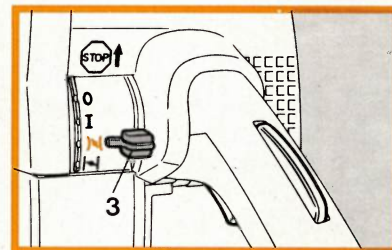







## Electrically Heated Handles (Option)

Heating switched on

### Other points to observe when starting:

The choke valve is operated by the Master Control lever (see "Master Control").

When starting a cold engine only keep the Master Control lever in the  position until the engine fires. Then move Master Control lever immediately to , even if the engine stops and you have continue cranking. If you leave the Master Control lever on , the combustion chamber will flood and stall the engine.

If you have moved the Master Control lever to  and the engine still does not run after several attempts, it is already flooded. In such a case, remove and dry off the spark plug. With the spark plug still removed, set the Master Control lever to  and crank the engine over several times with the starter to clear the combustion chamber. When you now try to start, move the Master Control lever to  – even if the engine is cold.

At very low outside temperatures you should still move the Master Control to  and disengage the throttle trigger from the starting throttle position by briefly accelerating the engine – but then warm up the engine at part throttle for a short period.

A new engine or one which has been run until the fuel tank is dry will not start first time after fueling because fuel will only begin to reach the carburetor after the engine has been cranked over several times.



The handle heating systems enables you to keep a warm, comfortable grip on the front and rear handles at extremely low outside temperatures.

The heating system is controlled by means of a switch on the handlebar. The symbols above and below the switch indicate the two switch positions: "0" for heating off – "I" for heating on, i.e. the switch must be moved to "I" to switch the heating on.

The heating system is designed to heat the front and rear handles to an adequate level. There is no risk of overheating during long periods of continuous operation. The whole heating system is maintenance-free.

## Winter Operation

Carburetor preheating flap

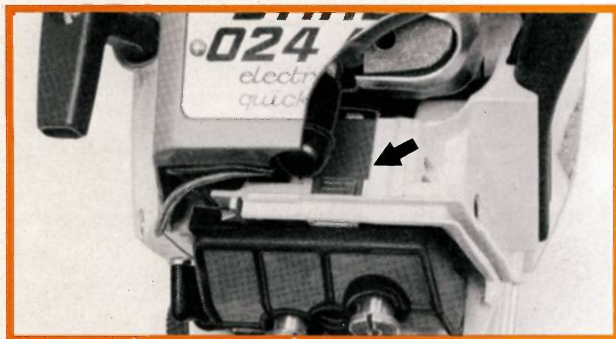

### Carburetor preheating

If outside temperatures are below  $+10^{\circ}\text{C}$  ( $50^{\circ}\text{F}$ ), change the flow of intake air to the carburetor to "winter operation" to avoid the carburetor icing up. To do this, use the carburetor screwdriver to open the flap in the housing just under the spark plug. This causes hot air from around the cylinder to be drawn in along with cold outside air.

The carburetor preheating flap **must** be closed at temperatures above  $+20^{\circ}\text{C}$  ( $70^{\circ}\text{F}$ ) to avoid engine running problems. To do this, remove the carburetor box cover and use the carburetor screwdriver to press down the flap until it snaps into position. Refit carburetor box cover.

### Note:

The cylinder shroud has been cut away in the illustrations for the sake of clarity.

Top: Opening the flap  
Center: Carburetor preheating flap open  
Bottom: Closing the flap

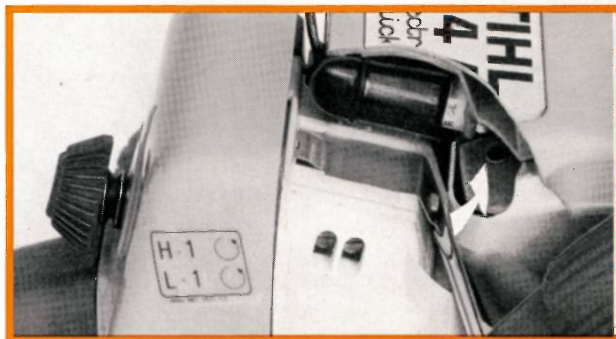

### Intake air preheating kit (optional extra)

The intake air preheating kit is recommended in extreme wintery operating conditions (temperatures below  $-10^{\circ}\text{C}$ / $+14^{\circ}\text{F}$  and in powder or drifting snow). Once it is fitted, the kit causes heated air to be drawn in from around the cylinder instead of cold outside air. This prevents air filter and carburetor icing. Furthermore, the cover plate blanks off the lower slots in the air filter housing to help prevent snow being sucked into the machine.

Detail assembly instructions are supplied with each intake air preheating kit.

**Important:** The carburetor preheating flap (see “Carburetor preheating”) must be open when the intake air preheating kit is fitted.

**Note:** If the saw is very cold (frost or ice on machine), start the engine and keep it at a high idle speed until it reaches normal operating temperature and idles smoothly.

Owing to the modified air flow when the kit is fitted, the air filter may tend to load up with dust at a faster rate. If this is the case, clean the air filter more frequently.

In the event of engine running problems, first check that conditions specified for use of the intake air preheating kit still apply (see assembly instructions for intake air preheating kit).

Top: Special carburetor box cover fitted

Bottom: Cover plate in position

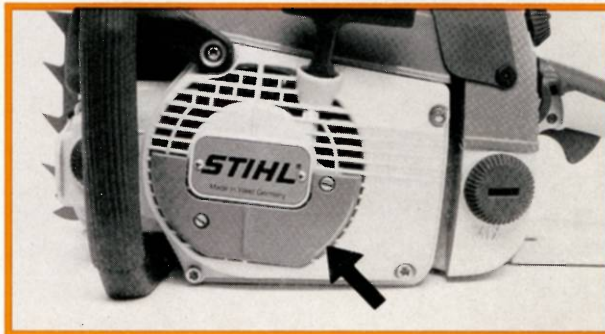
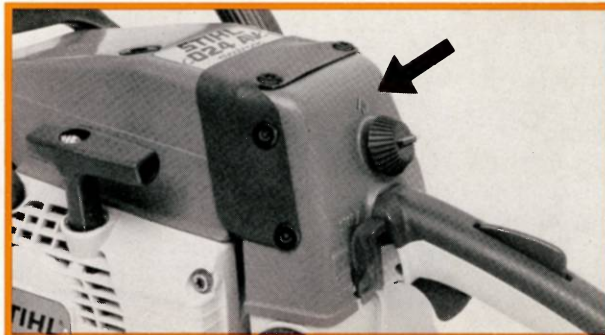

## Guide Bar, Chain and Sprocket

### Guide bar

The nose and underside of the guide bar are subject to a particularly high rate of wear. To avoid one-sided wear, turn the bar over every time you sharpen or replace the chain. Regular cleaning of the oil inlet holes and guide bar groove is also important. The bar can be examined for signs of wear at the same time.

A minimum bar groove depth must be maintained in order to prevent the drive links contacting the bottom of the groove (the heels of the cutter and tie strap would no longer ride on the guide bar rails). The groove depth varies according to chain type and pitch:

| Chain type | Chain pitch | Minimum depth  |
|------------|-------------|----------------|
| Rapid      | 0.325"      | 6 mm (0.24")   |
| Topic      | 0.325"      | 6,5 mm (0.26") |

The groove depth should be measured at the point where the bar is stressed most. That is the bar nose on Duromatic bars and the area where most of the cutting is done on Rollomatic bars. The guide bar must be replaced when groove depth is less than the specified minimum.

On Rollomatic guide bars it is not necessary to separately lubricate the sprocket nose bearing because the chain oil which flows to the bearing by way of the bar groove during normal operation is adequate for lubrication.

### Checking chain lubrication



### Breaking in Oilomatic chain

Every new chain has to be broken in for about 2 to 3 minutes. Ample chain lubrication is essential during this period. After breaking in, stop the engine, check chain tension and adjust if necessary.

### Chain lubrication

Never operate the chain saw without proper chain lubrication. If the chain is allowed to run dry the whole cutting attachment will be irretrievably damaged within a very short time. For this reason you should always check operation of the chain lubricating system and the level in the oil tank before starting work.

Start the saw and hold the cutting attachment over a light patch of ground. Take care – the Oilomatic chain must not touch the ground; hold it at least 20 cm (8 in) clear of the ground. Run the engine at about half throttle. If an increasing film of oil can be seen on the ground, chain lubrication is operating correctly.



### Chain tension

Apart from chain lubrication, chain tension is the factor that has the greatest influence of the cutting attachment's useful life. It is therefore necessary to check chain tension before starting work and at regular short intervals during cutting work. Chain tension is correct in the cold condition when the chain fits snugly against the underside of the bar and can still be pulled along the bar by hand (wear gloves!).

As it warms up to normal operating temperature the chain expands and sags noticeably. The saw chain must be retensioned when the drive links begin to come out of the groove on the underside of the bar. If this is not done, there is a risk of the chain jumping off the bar.

If the chain is retensioned during cutting work it must always be slackened off again after finishing work. This is necessary because high contraction stresses would otherwise occur as the chain cools down to ambient temperature, especially at extremely low outside temperatures, and cause damage to the crankshaft and bearings.

A new chain must be retensioned more frequently than a used one because it stretches during the initial break-in period.

### Chain sprocket

The stress and strain on the chain sprocket are particularly high. If the wear marks on the teeth are very pronounced (about 0.5 mm/0.02 in deep), the sprocket should be replaced. A worn sprocket reduces the service life of the

Worn chain sprocket

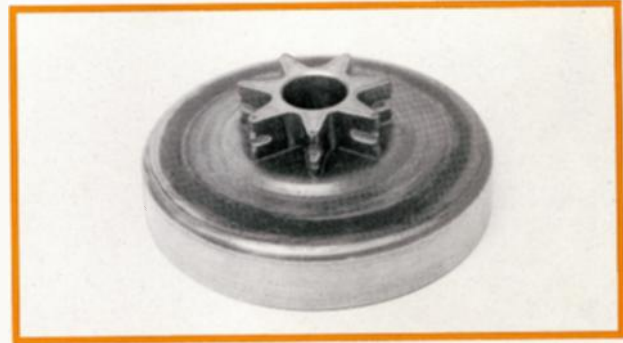

saw chain. The chain sprocket should be replaced as a matter of routine with every second Oilomatic chain. It is best to use two saw chains alternately with one sprocket.

two

## Replacing Chain Sprocket

Removing E-clip

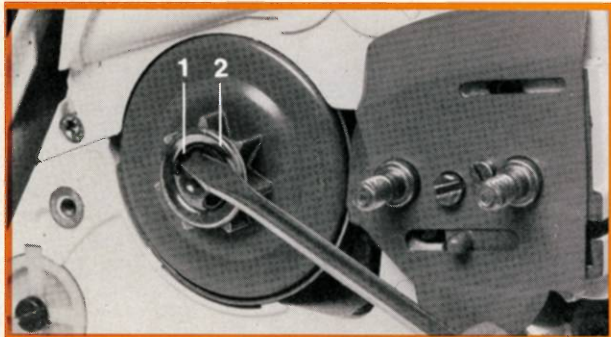

### Spur sprocket

First disengage the chain brake by pulling the hand guard back against the handlebar. Now remove the chain sprocket cover, Oilomatic chain and guide bar. Use a small screwdriver to prise the E-clip off the crankshaft.

Take the thrust washer (2), sprocket and needle cage off the crankshaft.

Clean the stub of the crankshaft, wash the needle cage in clean gasoline and lubricate with STIHL grease 0781 120 1111.

Reverse the above sequence for reassembly.

Use only original STIHL chain sprockets to ensure correct operation of the chain brake.

### Rim sprocket

40

First remove the chain sprocket cover, Oilomatic chain and guide bar.

Top: Spur sprocket  
Bottom: Rim sprocket

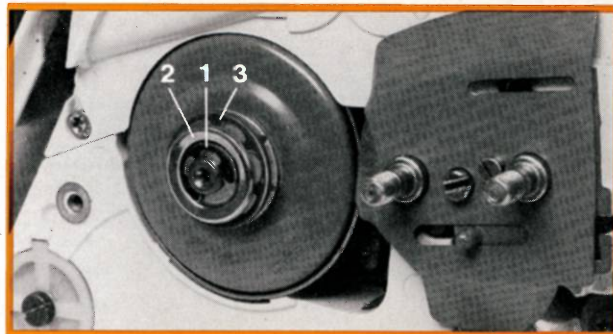
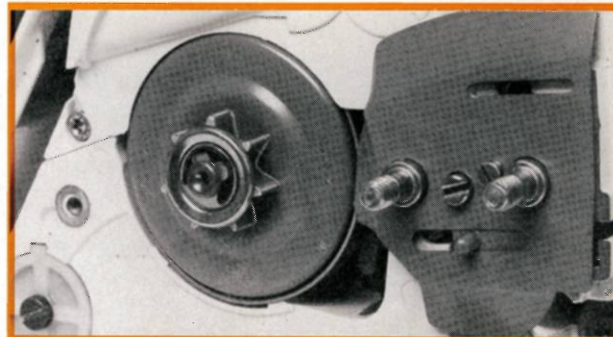

Use a small screwdriver to prise the E-clip off the crankshaft. Take off the thrust washer and rim sprocket (3).

Fit the new rim sprocket (3) so that the side with the cavities faces outward.

Finish off by refitting the thrust washer (2) and E-clip (1) on the crankshaft.

Use only original STIHL clutch drums to ensure correct operation of the chain brake.

## Air Filter

Removing carburetor box cover



The air filter's function is to intercept dust and dirt in the intake air and thus reduce wear on engine components.

A clogged air filter will reduce the power developed by the engine, increase fuel consumption and make starting difficult.

**Clean the air filter daily or more often if the air is exceptionally dusty in the work area.**

To remove the air filter, first take off the carburetor box cover by firmly pressing in the twist lock and turning it about  $\frac{1}{4}$  turn counterclockwise up to the detent position. Some machines have an integrally molded rib on the twist lock to indicate its position. When the rib is vertical (in line with arrow above the twist lock), the carburetor box cover may be pulled off **upward**.

Before disassembling any further, clean away dirt from exterior of filter and the area around it. Then use a screwdriver to unscrew the two slotted nuts.

Pull the two-part air filter off the mounting studs. Now prise apart the two halves of the filter by inserting a screwdriver in the slot provided.

Unscrewing slotted nuts



For daily cleaning it is sufficient to clean the prefilter (special accessory on Wood Boss) and the main filter with a natural bristle paint brush. In addition to this you should wash the complete air filter in a fresh, non-flammable cleaning solution (lukewarm soapy water) at least once a week and blow it out with compressed air if possible.

**Important:** Flocked filter elements must not be cleaned with compressed air, brushes or rags.

If the wire mesh is damaged in either half on the filter, replace the part concerned. It is also important to ensure that the choke shutter in the filter is in good condition.

When refitting the carburetor box cover make sure that the twist lock is in the detent position (rib on twist lock must be vertical). The groove on the left-hand side of the cover must engage in the housing guide.

Push the cover downward as far as the stop, then press in the twist lock firmly and secure it by turning  $\frac{1}{4}$  turn to the right (rib on twist lock must be horizontal).

## Carburetor

- 1 = High speed adjusting screw
- 2 = Low speed adjusting screw
- 3 = Idle speed adjusting screw

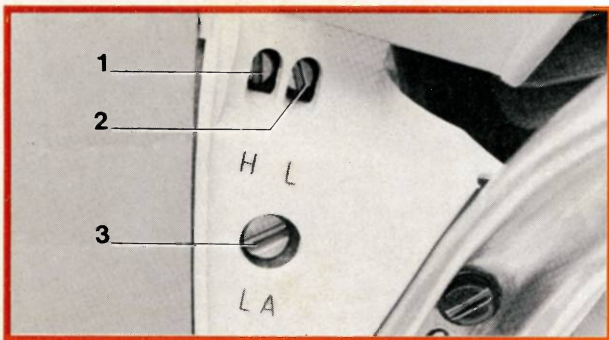

When the engine is tested at the factory the carburetor is set to obtain a slightly richer mixture to ensure that the cylinder bore and the bearings receive additional lubrication during the break-in period. This setting should be left as it is for the first three tank fillings. The high speed adjusting screw may then be turned no more than  $\frac{1}{4}$  turn clockwise (leaner mixture). Caution: The engine's maximum permissible rpm must not be exceeded!

If you use your chain saw at high altitudes (mountains) or at sea level it may be necessary to change the carburetor setting slightly. Carry out the correction at the two adjusting screws (L and H) as follows: Turn clockwise (leaner) for high altitude operation or counterclockwise (richer) for operation at sea level.

Note that even slight alterations on the adjusting screws have a noticeable effect on the engine's running behavior. Only carry out carburetor adjustments after cleaning the air filter and warming up the engine.

**Caution:** Adjustment of the high speed adjusting screw not only affects the power output but also the maximum off-load engine speed. If the setting is too lean (screw turned too far clockwise), the maximum permissible engine

Regulating idle speed adjusting screw

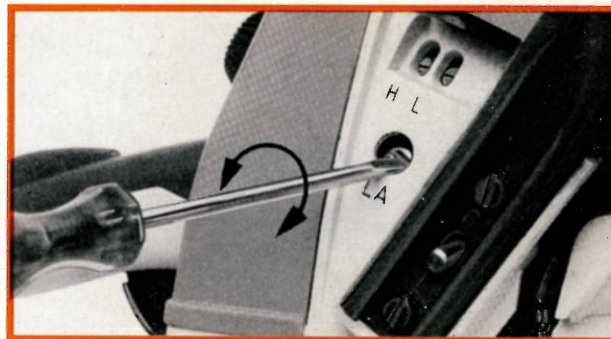

speed will be exceeded. This can cause engine damage, brought about by lack of lubrication and overheating in particular. Corrections to the setting of the high speed adjusting screw may be carried out only if an accurate tachometer is available to check the maximum engine speed of 13,000 rpm (with bar and correctly tensioned chain).

### Basic setting

If it is necessary to readjust the carburetor again from the beginning, first carry out the basic setting to obtain a starting point for fine adjustment. To do this, carefully screw the two adjusting screws down onto their seats (clockwise). Then make the following adjustment:

**High speed adjusting screw H:** back off 1 complete turn  
**Low speed adjusting screw L:** back off 1 complete turn

If you have no means of checking the maximum engine speed, do not set the high speed adjusting screw any leaner by turning it beyond the basic setting.

## **Notes for adjusting idle speed**

### **Engine stops while idling**

Turn idle speed adjusting screw (LA) clockwise until chain begins to run. Then back off one quarter of a turn.

### **Chain runs when engine is idling**

Turn idle speed adjusting screw (LA) counterclockwise until chain stops running and then turn it about another quarter turn in the same direction.

### **Erratic idling behavior; poor acceleration**

Idle setting too lean; turn low speed adjusting screw (L) counterclockwise until engine runs and accelerates smoothly.

### **Exhaust smokes at idle speed**

Idle speed setting too rich; turn low speed adjusting screw (L) clockwise until engine speed drops. Then turn screw back one quarter turn and check that engine still accelerates smoothly when you open the throttle.

A correction at the low speed adjusting screw usually necessitates a change in the setting of the idle speed adjusting screw (LA).

Apart from minor readjustments, you should leave all carburetor setting and repair work to your STIHL dealer. STIHL dealers have trained staff and all the necessary servicing tools and equipment.

## Rewind Starter

Remove the mounting screws

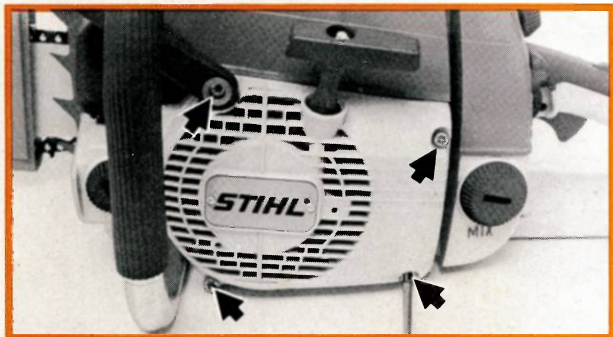

### Replacing a broken starter rope

First remove the three screws which retain the fan housing (8). Next lift the base of the fan shroud away from the crankcase and slide downward and away from the engine.

Using a screwdriver, or a suitable pair of pliers, carefully remove the spring clip (1) from the starter post groove. The rope rotor (2), together with the washer (3) and pawl (4) can now be lifted off.

Remove any remaining rope from the rope groove in the rotor (2). Thread in a new starter rope (5) (3.5 mm/0.15 in. dia. and 960 mm/37.8 in. long) and secure it at the pawl side of the rope rotor with a simple overhand knot. Thread the other end of the rope up through the rope guide hole in the fan housing (8) from the inside, pass it through the underside of the starter grip (6) and secure it with a special knot. Do not wind the rope onto the rotor at this stage.

Clean and lubricate the starter post with a non-resinous oil (low temperature lubricant 0781 417 1315). Slide the rotor onto the starter post and turn it back and forth until the loop of the rewind spring (7) engages in the slot.

Top: Possible special knots  
Bottom: Component parts of the starter assembly

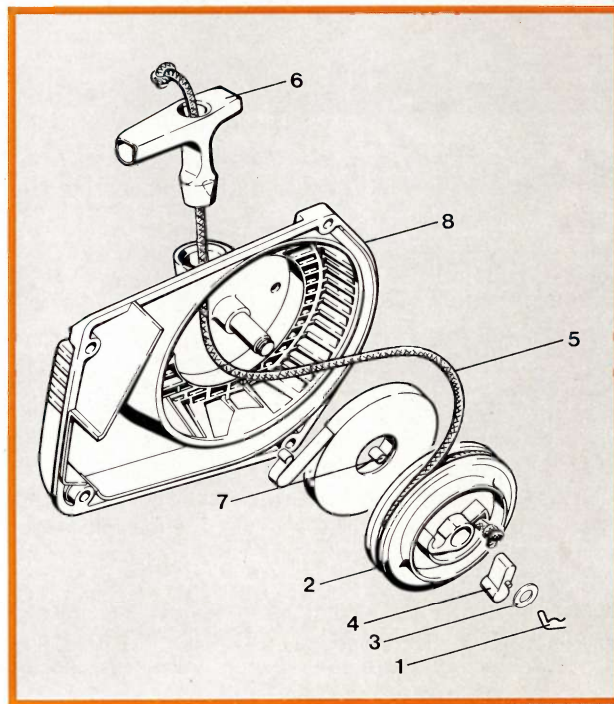
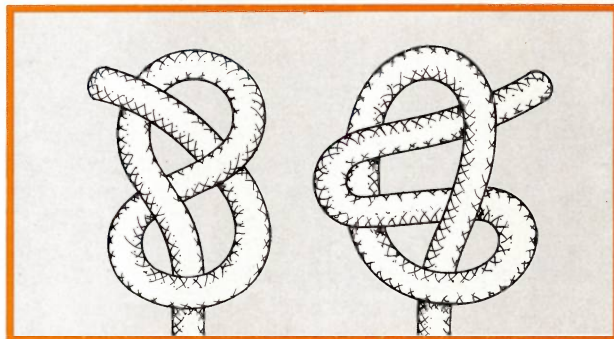

Installing the spring clip/position of knot



Now insert pawl in rope rotor and press spring clip onto starter post with a suitable pair of pliers, making sure that the spring clip engages on the pawl's guide pin and points it in the clockwise direction. Then tension rewind spring.

### Replacing a broken rewind spring

Remove the rope rotor as above. The spring housing together with the rewind spring can then be removed from the fan housing by turning the fan housing over and let it drop out of the recess in the fan housing. A replacement spring and spring housing are supplied as an assembly. Lubricate the spring with a few drops on non-resinous oil before installing it.

Drop the rewind spring/housing assembly (with the bottom plate area up) into the fan shroud recess. If the spring should pop out of its housing during installation re-insert it in its housing starting from outside to inside in counter-clockwise direction. Reassemble the rope rotor as above.

Tensioning the rewind spring

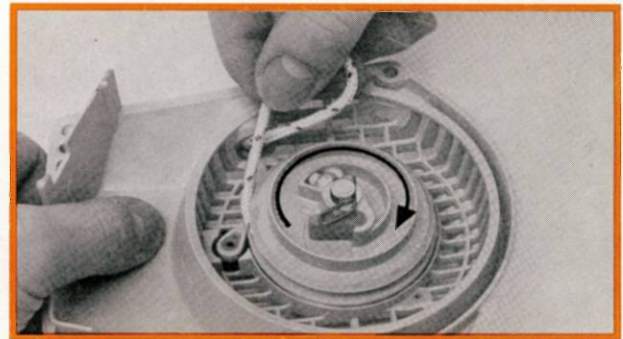

### Tensioning the rewind spring

With the starter rope (5) fully extended, make a loop in the rope between the rotor (2) and fan housing and use it to turn the rope rotor (2) six full revolutions clockwise. Hold the rope rotor steady in this position. Pull out and straighten the twisted rope (5). Now release the rope rotor gradually and allow spring force to wind the starter rope fully onto the rope rotor.

The rewind spring is tensioned correctly if the starter grip is held firmly in place against the starter housing by spring tension and does not droop. If more tension is required add one more turn on the rope rotor. The rope rotor should be able to be rotated by at least one-half an extra turn with the rope pulled all the way out. If spring tension is too great pull out the starter rope, hold the rotor firmly by hand, and remove one turn of the rope.

**A starter spring that is tensioned too heavily will probably break.**

Re-install the fan shroud with the retaining screws securely tightened.

# Maintenance Chart

|   |   | before starting work | after finishing work or daily | after each refueling stop | weekly | monthly | if faulty | if damaged | as required | see page: |
|---|---|----------------------|-------------------------------|---------------------------|--------|---------|-----------|------------|-------------|-----------|
| Complete machine  | Visual inspection (condition, leaks)        | x                    |                               | x                         |        |         |           |            |             |           |
|   | Clean                                       |                      | x                             |                           |        |         |           |            |             |           |
| Throttle trigger, throttle trigger lock, Master Control, depending on model | Check operation                             | x                    |                               | x                         |        |         |           |            |             |           |
| Chain brake   | Check operation                             | x                    |                               | x                         |        |         |           |            |             | 29        |
|   | Clean by STIHL Dealer                       |                      |                               |                           |        |         |           |            | x           |           |
| Filter in fuel tank   | Clean wire filter                           |                      |                               |                           |        | x       |           |            |             |           |
|   | Replace felt                                |                      |                               |                           |        |         |           | x          |             |           |
| Fuel tank   | Clean                                       |                      |                               |                           |        | x       |           |            |             |           |
| Chain oil tank  | Clean                                       |                      |                               |                           |        | x       |           |            |             |           |
| Chain lubrication   | Check                                       | x                    |                               |                           |        |         |           |            |             | 38        |
| Saw chain   | Inspect, also check sharpness               | x                    |                               | x                         |        |         |           |            |             |           |
|   | Check chain tension                         | x                    |                               | x                         |        |         |           |            |             | 39        |
|   | Sharpen                                     |                      |                               |                           |        |         |           |            | x           | 49        |
| Guide bar   | Inspect (wear, damage)                      | x                    |                               |                           |        |         |           |            |             | 38        |
|   | Clean and turn over                         |                      |                               |                           | x      |         | x         |            |             |           |
|   | Deburr                                      |                      |                               |                           | x      |         |           |            |             |           |
|   | Replace                                     |                      |                               |                           |        |         |           | x          | x           |           |
| Chain sprocket  | Check                                       |                      |                               |                           | x      |         |           |            |             | 39        |
| Air filter  | Clean                                       | x                    |                               |                           |        |         | x         |            |             | 41        |
|   | Replace                                     |                      |                               |                           |        |         |           | x          |             | 41        |
| Cooling inlets  | Clean                                       |                      | x                             |                           |        |         |           |            |             |           |
| Cylinder fins   | Clean                                       |                      |                               |                           |        | x       |           |            |             |           |
| Carburetor  | Check idle adjustment – chain must not turn | x                    |                               | x                         |        |         |           |            |             | 42        |
|   | Readjust idle                               |                      |                               |                           |        |         |           |            | x           | 42        |
| Spark plug  | Readjust electrode gap                      |                      |                               |                           |        |         | x         |            |             | 30        |
| All accessible screws and nuts (not adjusting screws)                       | Retighten                                   |                      |                               |                           |        |         |           |            | x           |           |
|   | Inspect                                     |                      |                               |                           | x      |         |           |            |             |           |
| Rubber vibration buffers  | To be replaced only by STIHL Dealer         |                      |                               |                           |        |         |           | x          |             |           |
|   | Inspect                                     | x                    |                               |                           |        |         |           |            |             |           |
| Spark arrestor screen   | Clean or replace                            |                      |                               |                           |        |         |           | x          |             |           |
|   | Check                                       | x                    |                               |                           |        |         |           |            |             |           |
| Chain catcher   | Replace                                     |                      |                               |                           |        |         |           | x          |             |           |



## Specifications

### Engine

STIHL single cylinder two-stroke engine

#### 024

Displacement: 41.6 cm<sup>3</sup> (2.54 cu. in)  
Bore: 42 mm (1.65 in)  
Stroke: 30 mm (1.18 in)

#### 024 S

Displacement: 44.3 cm<sup>3</sup> (2.70 cu. in)  
Bore: 42 mm (1.65 in)  
Stroke: 32 mm (1.32 in)

Max. engine speed with  
cutting attachment: 13,000 r.p.m.

### Ignition System

Principle: Electronic magneto ignition  
Ignition timing: 2.1 mm (0.083 in) before T. D. C.  
at 8,000 r.p.m.

Spark plug (suppressed): Bosch WSR 6 F or  
NGK BPMR 7 A  
Heat range 200  
Electrode gap 0.5 mm (0.02 in)  
Spark plug thread M 14×1.25;  
9.5 mm (0.37 in) long

### Fuel/Oil System

Carburetor: All position diaphragm carburetor with integral fuel pump  
Air filter: Flat, two-part wire mesh element  
Fuel tank capacity: 0.47 L (1 US pt)  
Fuel mixture: See chapter "Fuel"  
Chain lubrication: Speed controlled plunger-type oil pump  
Oil tank capacity: 0.32 L (0.67 US pt)

### Weight

without bar and chain: 4.8 kg (10.54 lb)

### Cutting Attachment

Recommended cutting attachments for compliance with § 4.12 of ANSI Standard B 175.1–1985 (see page 12 of this Manual):

---

STIHL reduced kickback bar (with green label):

for  $\frac{3}{8}$ " Picco pitch and 0.325" pitch:

Rollomatic with sprocket nose  
40, 45 or 50 cm (16; 18 or 20 in)

STIHL low kickback chain\* (with green label):

9.32 mm ( $\frac{3}{8}$ " Picco-Micro 1 (63 pm 1) or  
8.25 mm (0.325") Topic-Micro 1 (26 tm 1)

Chain sprocket:

8-tooth for  $\frac{3}{8}$ " Picco-pitch or 7-tooth for 0.325" pitch

---

Other cutting attachments available for this powerhead are:

STIHL yellow-labeled bar:

for 0.325" pitch:

Rollomatic "S" with sprocket nose  
40, 45 or 50 cm (16, 18 or 20 in)

Duromatic with stellite tipped nose  
40, 45 or 50 cm (16, 18 or 20 in)

STIHL yellow-labeled chain:

for 0.325" pitch: Topic-Micro (26 TM), Topic-Super (26 TS)

Since new bar/chain combinations may be developed after publication of this Manual, ask your STIHL dealer for the latest STIHL recommendations.

In order to comply with the kickback performance requirements of § 4.12 of ANSI Standard B 175.1–1985, do not use replacement saw chain unless it has been designated as meeting the ANSI § 4.12 requirements on this specific powerhead, or has been designated as "low kickback" saw chain\* in accordance with the ANSI B 175–1985 standard.

\* See definition of "low kickback chain" on p. 12 of this Manual. **47**

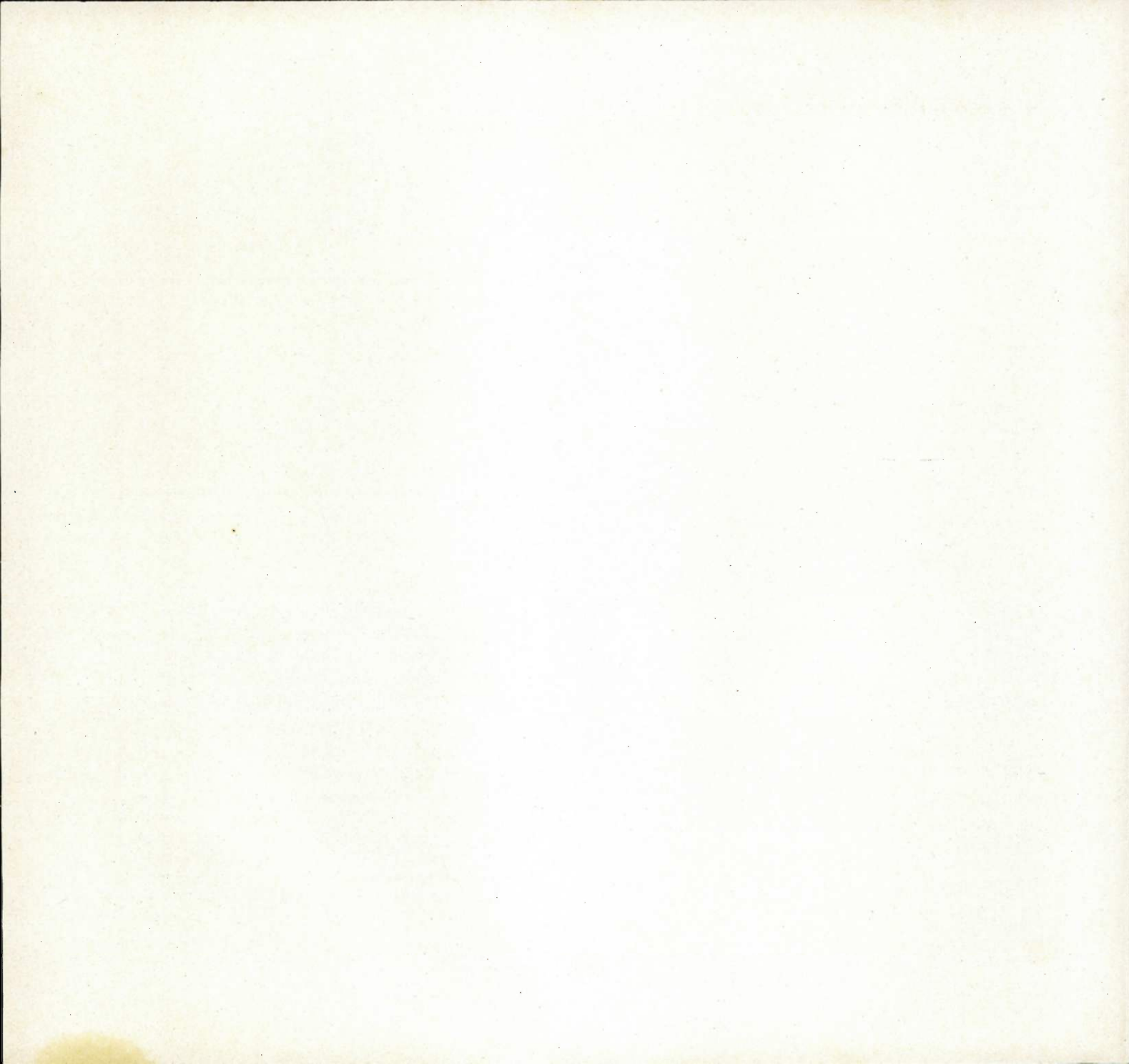

## Sharpening and Maintenance of Saw Chain

### Description of chains

The illustration on the right shows the component parts of a STIHL saw chain. Every chain manufactured by STIHL features the Oilomatic system. Apart from the three basic types (Rapid, Topic and Picco), there are three different versions whose names denote the cutter shape, i.e. chipper tooth = Standard, semi-chisel = Micro and full chisel = Super.

The main size measurement on a saw chain is the pitch. It is determined by measuring the distance between one rivet and the next but one and dividing the measurement by two. The result is the pitch which is generally specified in inch ( $\frac{3}{8}'' = 9.32 \text{ mm}$ ).

Like any other cutting tool, the saw chain is subject to normal wear and tear. A properly sharpened chain slices through wood and requires very little infeed effort. For this reason alone you should never attempt to cut with a dull or damaged chain. There are a few crucial angles which must be observed in order to obtain good results when sharpening a chain. They are explained below.

### Filing angle

The filing angle for Rapid-Standard, Rapid-Micro and Topic-Micro chains is  $35^\circ$ ; these chains are sharpened to this angle before leaving the factory. However, if you want to use the chain primarily for cutting hardwood or frozen timber, it is best to sharpen it to an angle of  $30^\circ$ . Rapid-Super and Topic-Super chains are always sharpened to  $30^\circ$ .

It is essential to ensure that the filing angle is kept exactly the same on all cutters. Irregular angles will cause the chain to run roughly and unevenly as well as accelerate the rate of wear and increase the risk of breakage.

Top: Component parts of an Oilomatic chain  
Bottom: Measuring chain pitch "t"

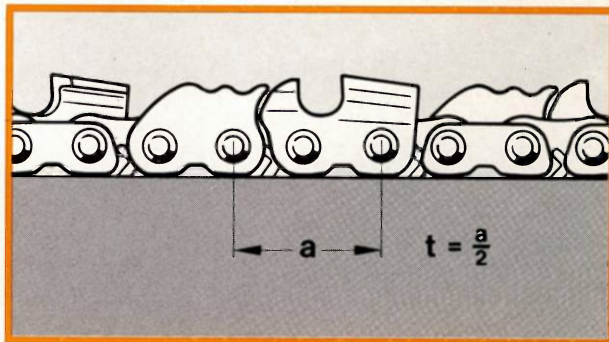
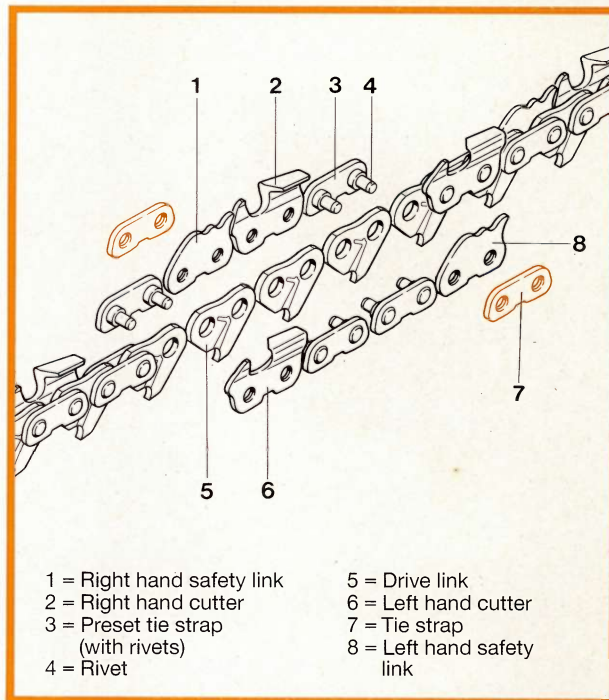

Top: Filing angle  
 Center: Side plate angle  
 Bottom: Table of file diameters

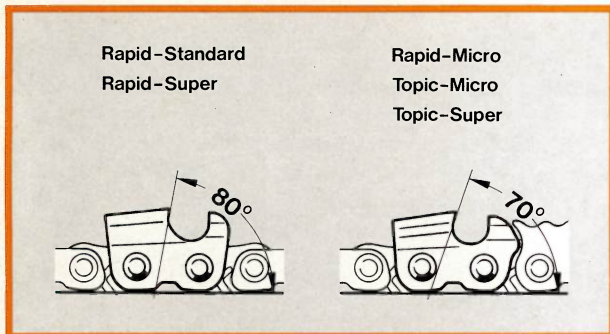
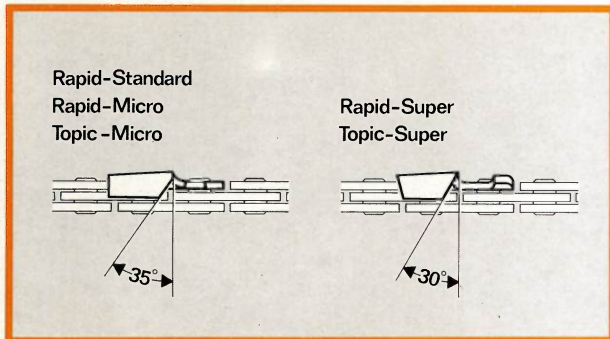

| Chain pitch      | File dia.            | File No.      |
|------------------|----------------------|---------------|
| .325" (8.25 mm)  | Rapid 3/16" (4.8 mm) | 0811 411 8088 |
| .325" (8.25 mm)  | Topic 5/32" (4.0 mm) | 0814 242 3383 |
| 3/8" (9.32 mm)   | Rapid 3/16" (4.8 mm) | 0811 411 8088 |
| 3/8" (9.32 mm)   | Topic 5/32" (4.0 mm) | 0814 242 3383 |
| .404" (10.26 mm) | 3/16" (4.8 mm)       | 0811 411 8088 |
| 1/2" (12.7 mm)   | 1/4" (6.3 mm)        | 0811 411 8118 |

## Side plate angle

The upright cutting edge just below the top plate is known as the side plate cutting edge. The side plate angle is, therefore, the angle between the side plate cutting edge and the horizontal line formed by the cutter toe and heel. The following side plate angles are specified:

|                |     |             |     |
|----------------|-----|-------------|-----|
| Rapid-Standard | 80° | Topic-Micro | 70° |
| Rapid-Micro    | 70° | Topic-Super | 70° |
| Rapid-Super    | 80° |             |     |

These angles are obtained automatically if you use a file holder or roller filing guide with the specified size of file (diameter) and hold the file correctly during sharpening.

## Top plate cutting angle

The top plate cutting angle is the most important angle since it influences the chain's cutting behavior. It is also obtained automatically if sharpening is performed properly with a suitable STIHL sharpening tool.

## Sharpening

Only special saw chain files may be used for sharpening and they must match the chain concerned (basic type, pitch). The shape and cut of machinists' files makes them unsuitable for saw chain. It is best to use the special chain file with a file holder or other filing aid. **Always file from the inside to the outside of the cutter.** If you sharpen the chain while it is on the bar, increase chain tension before filing and reset it to correct tension afterward.

All cutters must be filed to the same length. Since the top plate slopes downward to the rear (clearance angle), the

Top: File position for Rapid-Standard, Rapid-Micro and Topic-Micro

Bottom: Sharpening with file holder

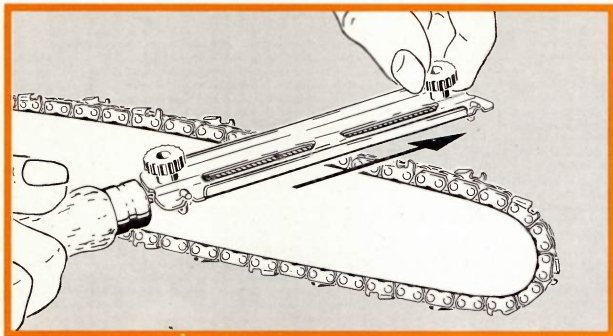
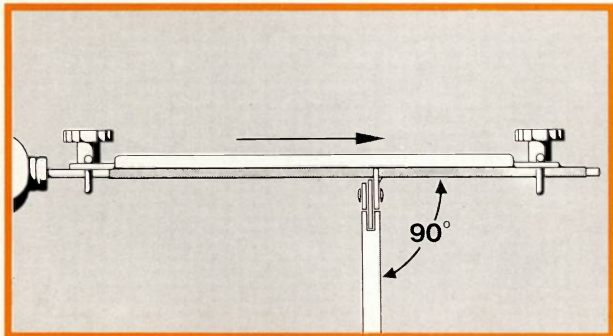

cutter heights will be uneven if the cutter lengths are different. If the cutters are not all the same height the chain will run roughly and eventually break.

As it is very important to achieve uniform cutter lengths, it is best to measure them with a slide caliper. Find and sharpen the shortest cutter first and then use it as a master for all the others, i.e. all cutters must be filed back to the same length as the master cutter. Sharpen all the cutters on one side of the chain first and then repeat the procedure on the other side.

The file must be held level for **Rapid-Standard, Rapid-**

File position for Rapid-Super and Topic-Super

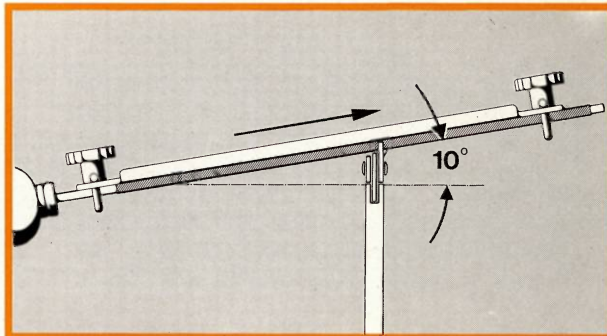

**Micro and Topic-Micro chain** so that it is at 90° to the perpendicular faces of the chain links or the guide bar.

On **Rapid-Super and Topic-Super chains**, hold the file so that it slopes upwards toward the top plate at 10°, i.e. the file handle should be 10° lower than the tip of the file. If you use your saw for cutting softwood in mild weather conditions (no frost), you can hold the file horizontal (at right angle to chain) for resharpening. Note that a filing aid (file holder, filing tool) or electric grinder must be used for resharpening Super chains.

File evenly and steadily and note that the file **only sharpens on the forward stroke**. Lift the file off the cutter on the backstroke. Make sure you do not touch the tie straps and drive links with the file. Use a piece of hardwood to remove burrs from the cutting edge.

**Important:** Sharpen the chain frequently and take away as little material as possible. Two or three strokes of the file are usually sufficient to keep the chain sharp. Variations in angles and the lengths of the cutters cannot be completely avoided during manual sharpening. For this reason the chain should be restored to its original condition with a workshop chain sharpener (STIHL USG, STIHL FG 2) after it has been resharpened about five times by hand.

## Depth gauges

The depth gauge determines the height at which the cutter enters the wood and thus the thickness of the chip removed. The cutting capacity and life of a saw chain are therefore influenced by the distance between the depth gauge and the cutting edge, i.e. the depth gauge setting. This setting varies according to chain pitch and must be checked with the appropriate filing gauge.

The best cutting results are obtained with the settings listed in the table. However, the depth gauge setting may be increased by 0.2 mm for cutting softwood in mild weather conditions.

Since the depth gauge setting is reduced when the cutter is sharpened, its height must be checked and lowered if necessary. If the depth gauge projects from the filing gauge, it must be filed down level with the gauge using a flat or triangular file. The contour of the depth gauge must also be rounded off on Rapid chain. In the case of Topic chains the depth gauge should be rounded off in line with the stamped markings.

## General chain maintenance

Chain maintenance begins as soon as the chain is fitted on the bar and sprocket. The essential points are **correct chain tension and ample lubrication**. See also "Guide Bar, Chain and Sprocket".

Clean the chain thoroughly in gasoline after sharpening to remove filings or grinding dust. Then lubricate the chain by

Top: Table of recommended depth gauge settings  
Center: Depth gauge setting  
Bottom: Filing down depth gauge (Topic chain)

| Chain pitch      | Setting | Filing gauge  |
|------------------|---------|---------------|
| .325" (8.25 mm)  | 0.65 mm | 1110 893 4000 |
| 3/8" (9.32 mm)   | 0.65 mm | 1110 893 4000 |
| .404" (10.26 mm) | 0.8 mm  | 1106 893 4000 |
| 1/2" (12.7 mm)   | 0.8 mm  | 1106 893 4000 |
| 090 G chain saw  |         |               |
| 1/2" (12.7 mm)   | 1.2 mm  | 1106 893 4010 |

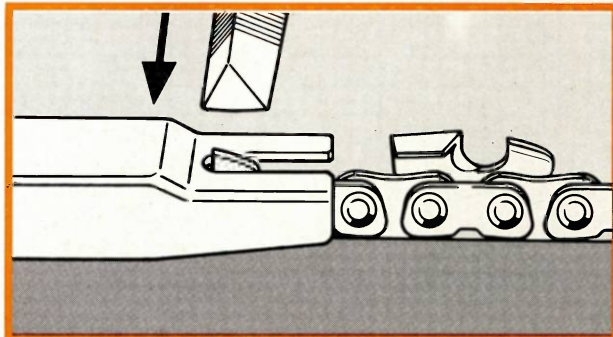
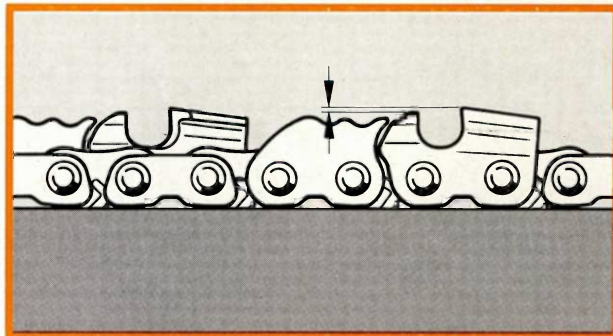

immersing it in an oil bath. If you are not going to use the chain for a prolonged period, clean it with a brush and immerse it in an oil-paraffin bath.

Carefully examine chain for cracks in the links or damaged rivets while you are sharpening and cleaning it. Any damaged or worn parts must be replaced. The new parts must be reworked to match the shape and size of the original parts.

Chain repairs can be carried out with the STIHL handheld chain breaking and rivet spinning tool, the STIHL NG 1 or NG 5 rivet spinners and the STIHL NG 4 chain breaker.

### Tools for chain maintenance

There is a range of chain sharpening aids and tools to suit the user's needs (frequency of sharpening, time required etc.).

**File holders**, which have reference marks for the filing angle, simplify chain sharpening and are available for all types of chain.

The **FG 1 filing tool** attaches to the guide bar and sharpens all types of chain.

The **STIHL FG 2 Filerite and USG universal electric sharpener** are workshop tools suitable for sharpening all types of chain.

Table of file holders

| Chain pitch<br>inch (mm) | Chain          | File holder<br>Part No. |
|--------------------------|----------------|-------------------------|
| .325 (8.25)              | Rapid-Micro    | 5605 750 4326           |
| .325 (8.25)              | Rapid-Super    | 5605 750 4336           |
| .325 (8.25)              | Topic-Micro    | 5605 750 4321           |
| .325 (8.25)              | Topic-Super    | 5605 750 4351           |
| $\frac{3}{8}$ (9.32)     | Rapid-Standard | 5605 750 4326           |
| $\frac{3}{8}$ (9.32)     | Rapid-Micro    | 5605 750 4326           |
| $\frac{3}{8}$ (9.32)     | Rapid-Super    | 5605 750 4336           |
| $\frac{3}{8}$ (9.32)     | Topic-Micro    | 5605 750 4321           |
| $\frac{3}{8}$ (9.32)     | Topic-Super    | 5605 750 4351           |
| .404 (10.26)             | Rapid-Standard | 5605 750 4326           |
| .404 (10.26)             | Rapid-Micro    | 5605 750 4326           |
| .404 (10.26)             | Rapid-Super    | 5605 750 4336           |

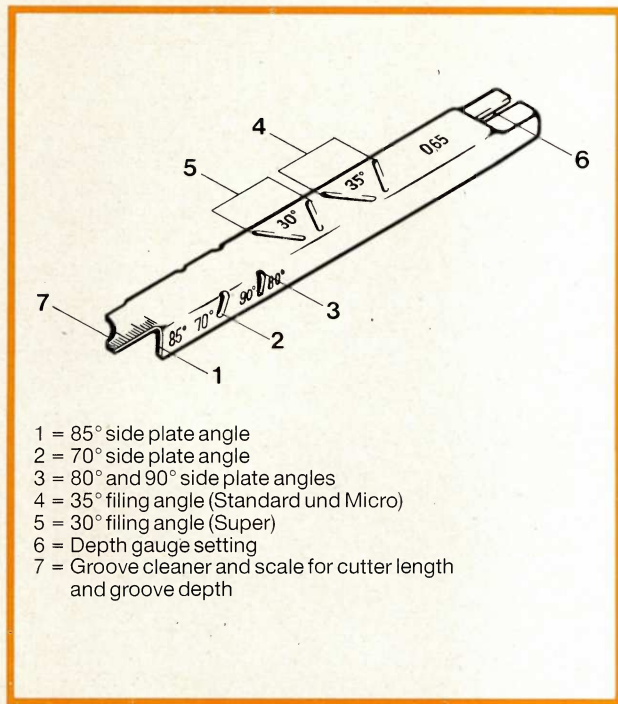

The **filing gauge** is a universal tool for checking the filing and side plate angles as well as the depth gauge setting and cutter length. It can also be used for cleaning the guide bar groove and oil inlet hole and measuring the groove depth. The following filing gauges are available:

Filing gauge 1110 893 4000 for 0.325" and 3/8" chain (0,65 mm depth gauge setting).

Filing gauge 1106 893 4000 for 0.404" and 1/2" chain (0,8 mm depth gauge setting).

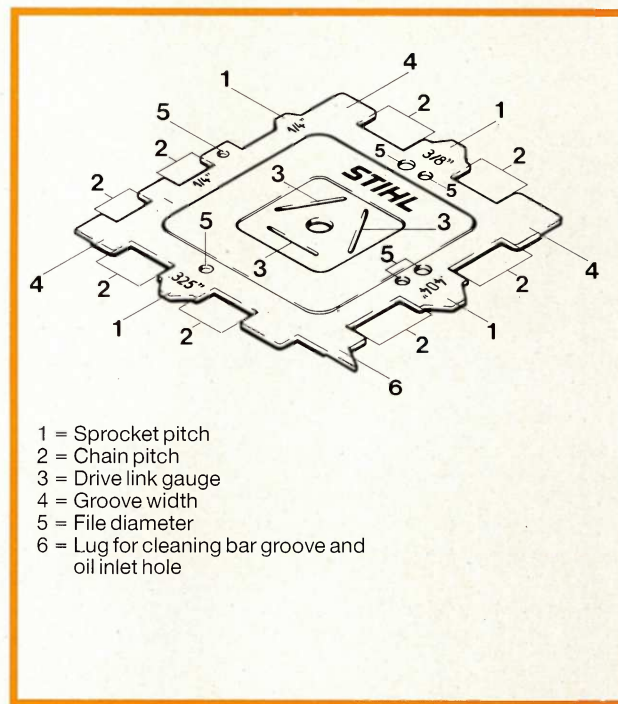

The **reference gauge 0000 893 4105** is used to determine the distinguishing characteristics of saw chains and guide bars. Furthermore, it can be used to clean the guide bar groove and oil inlet hole as well as check the diameter of the chain sharpening file.



## Ordering Spare Parts

Please enter your saw model, machine number as well as the part number of the guide bar, saw chain and chain sprocket in the space provided on this page. This will make re-ordering simpler.

The guide bar, saw chain and chain sprocket are subject to normal wear and tear.

The part numbers for the standard bar, chain and sprocket are printed on the right for your convenience.

When purchasing these parts, always quote the saw model, the part numbers and names of the parts.

|                             |                      |                      |                      |                      |                      |                      |                      |                      |                      |                      |                      |                      |                      |                      |                      |                      |                      |                      |                      |
|-----------------------------|----------------------|----------------------|----------------------|----------------------|----------------------|----------------------|----------------------|----------------------|----------------------|----------------------|----------------------|----------------------|----------------------|----------------------|----------------------|----------------------|----------------------|----------------------|----------------------|
| <b>Model description</b>    | <input type="text"/> | <input type="text"/> | <input type="text"/> | <input type="text"/> | <input type="text"/> | <input type="text"/> | <input type="text"/> | <input type="text"/> | <input type="text"/> | <input type="text"/> | <input type="text"/> | <input type="text"/> | <input type="text"/> | <input type="text"/> | <input type="text"/> | <input type="text"/> | <input type="text"/> | <input type="text"/> | <input type="text"/> |
| <b>Serial number</b>        | <input type="text"/> | <input type="text"/> | <input type="text"/> | <input type="text"/> | <input type="text"/> | <input type="text"/> | <input type="text"/> | <input type="text"/> | <input type="text"/> | <input type="text"/> | <input type="text"/> | <input type="text"/> | <input type="text"/> | <input type="text"/> | <input type="text"/> | <input type="text"/> | <input type="text"/> | <input type="text"/> | <input type="text"/> |
| <b>Chain part number</b>    | <input type="text"/> | <input type="text"/> | <input type="text"/> | <input type="text"/> | <input type="text"/> | <input type="text"/> | <input type="text"/> | <input type="text"/> | <input type="text"/> | <input type="text"/> | <input type="text"/> | <input type="text"/> | <input type="text"/> | <input type="text"/> | <input type="text"/> | <input type="text"/> | <input type="text"/> | <input type="text"/> | <input type="text"/> |
| <b>Guide bar number</b>     | <input type="text"/> | <input type="text"/> | <input type="text"/> | <input type="text"/> | <input type="text"/> | <input type="text"/> | <input type="text"/> | <input type="text"/> | <input type="text"/> | <input type="text"/> | <input type="text"/> | <input type="text"/> | <input type="text"/> | <input type="text"/> | <input type="text"/> | <input type="text"/> | <input type="text"/> | <input type="text"/> | <input type="text"/> |
| <b>Sprocket part number</b> | <input type="text"/> | <input type="text"/> | <input type="text"/> | <input type="text"/> | <input type="text"/> | <input type="text"/> | <input type="text"/> | <input type="text"/> | <input type="text"/> | <input type="text"/> | <input type="text"/> | <input type="text"/> | <input type="text"/> | <input type="text"/> | <input type="text"/> | <input type="text"/> | <input type="text"/> | <input type="text"/> | <input type="text"/> |

**For recommended STIHL reduced kickback cutting attachments see section "Specifications" of this Owner's Manual.**

Warranty claims following repairs can be accepted only if the repair has been performed by an authorized STIHL Service Shop using original STIHL spare parts.

Original STIHL parts can be identified by the STIHL part number, the **STIHL**® logo and the STIHL parts symbol .

The symbol may appear alone on small parts.



Continuation of  
Important Safety Precautions

4. Do not allow other persons to be near the chain saw when starting or cutting with the chain saw. Keep bystanders and animals out of the work area.
5. Do not start cutting until you have a clear work area, secure footing, and a planned retreat path from the falling tree.
6. Keep all parts of your body away from the saw chain when the engine is running.
7. Before you start the engine, make sure that the saw chain is not contacting anything.
8. Carry the chain saw with the engine stopped, the guide bar and saw chain to the rear, and the muffler away from your body.
9. Do not operate a chain saw that is damaged, improperly adjusted, or not completely and securely assembled. Be sure that the saw chain stops moving when the throttle control trigger is released.
10. Shut off the engine before setting the chain saw down.
11. Use extreme caution when cutting small size brush and saplings because slender material may catch the saw chain and be whipped toward you or pull you off balance.
12. When cutting a limb that is under tension, be alert for springback so that you will not be struck when the tension in the wood fibers is released.
13. Keep the handles dry, clean, and free of oil or fuel mixture.
14. Operate the chain saw only in well-ventilated areas.
15. Do not operate a chain saw in a tree unless you have been specifically trained to do so.
16. All chain saw service, other than the items listed in the Owner's Manual maintenance instructions, should be performed by competent chain saw service personnel. (For example, if improper tools are used to remove the flywheel or if an improper tool is used to hold the flywheel in order to remove the clutch, structural damage to the flywheel could occur and could subsequently cause the flywheel to burst.)
17. When transporting your chain saw, use the appropriate guide bar scabbard.
18. Reduced kickback bars and low kickback chains are designed to reduce the risk of kickback injury. Ask your STIHL dealer about these devices.

**Note:**

When using a chain saw for logging purposes, refer to the Code of Federal Regulations, Section 1910.266(5); 2.5.1 of American National Standard Safety Requirements for Pulpwood Logging, ANSI O3.1-1978; and relevant state safety codes.

**englisch/english U.S.A.**

## **Observe this page!**

### **Erratum**

This instruction Manual/ Owner's Manual refers on various pages to ANSI-Standard B 175.1-1985. Please note that the latest edition of this standard was issued in 1991 and the correct standard reference therefore should read: "ANSI B175.1-1991" throughout this manual. Especially the section 4.12 in the 1985 edition was changed into 5.12.

### **Ammendment:**

Please note the following additional important safety precaution for chain saw users:

- Do *not* operate a chain saw with one hand! Serious injury to the operator, helpers, bystanders, or any combination of these persons may result from one-handed operation. A chain saw is intended for two-handed use.

**DO NOT REMOVE THIS PAGE!**

**FILE IN OWNER'S MANUAL!**